



125 TE 2012



SPARE PARTS MANUAL: ENGINE

ART.NO.: 3CM081570LEN

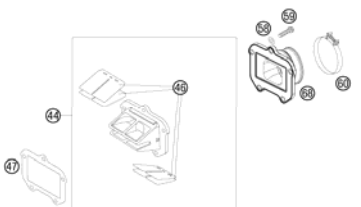
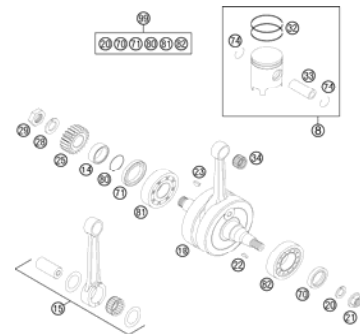
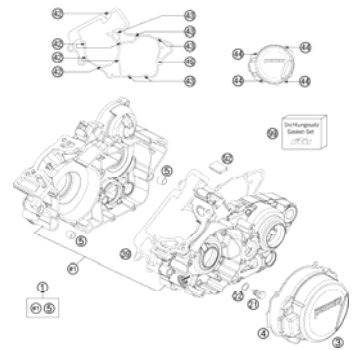
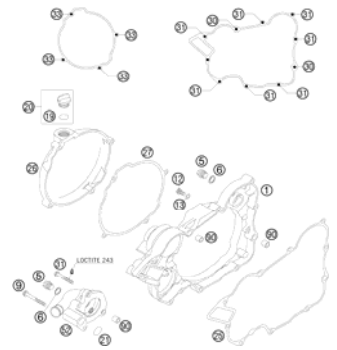
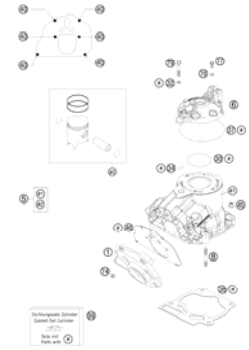
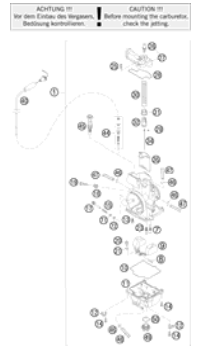
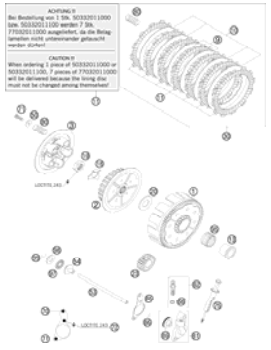
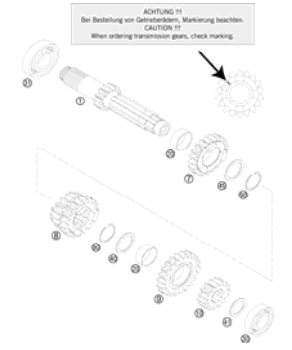
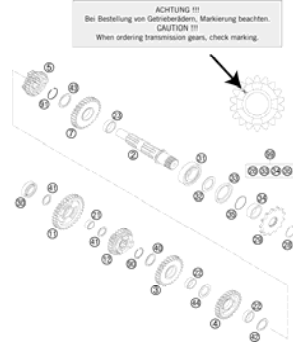
ENGLISH

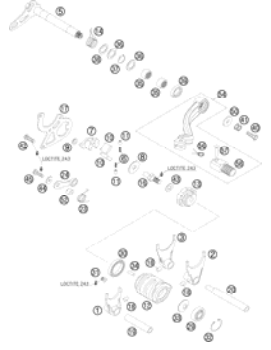
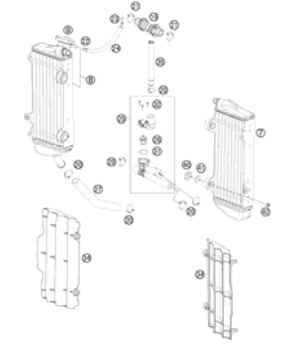
HUSABERG

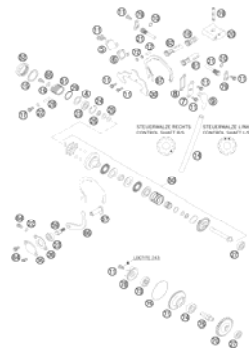
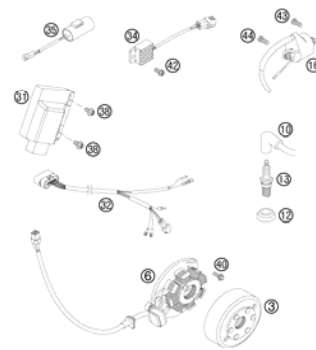
<p>REED VALVE CASE</p>  <p>3</p>	<p>CRANKSHAFT, PISTON</p>  <p>4</p>	<p>ENGINE CASE</p>  <p>5</p>	<p>CLUTCH COVER</p>  <p>6</p>
<p>CYLINDER, CYLINDER HEAD</p>  <p>7</p>	<p>CARBURETOR</p>  <p>8</p>	<p>CLUTCH</p>  <p>10</p>	<p>TRANSMISSION I - MAIN SHAFT</p>  <p>11</p>
<p>TRANSMISSION II - COUNTERSHAFT</p>  <p>12</p>	<p>KICK STARTER</p>  <p>13</p>	<p>SHIFTING MECHANISM</p>  <p>14</p>	<p>COOLING SYSTEM</p>  <p>16</p>

<p>EXHAUST CONTROL</p>  <p style="text-align: right;">17</p>	<p>IGNITION SYSTEM</p>  <p style="text-align: right;">19</p>		
	<div style="display: flex; align-items: center;">  <p>All information contained is without obligation. KTM-Sportmotorcycle AG particularly reserves the right to modify any equipment, technical specifications, prices, colors, shapes, materials, services, service work, constructions, equipment and the like so as to adapt them to local conditions or to cancel any of the above items, all without previous announcement and without giving reasons. KTM may stop manufacturing certain models without previous notice. KTM shall not be held liable for any deviations of availability and/or ability to deliver, illustrations, descriptions, printing and/or other errors. The illustrated models partly contain extra equipment, which is not applied to standard models. © by KTM-SPORTMOTORCYCLE AG, Mattighofen AUSTRIA; All rights reserved; Reprint, also in extracts, with written allowance of KTM-SPORTMOTORCYCLE AG, Mattighofen only.</p> </div>		

REED VALVE CASE

125 TE 2012

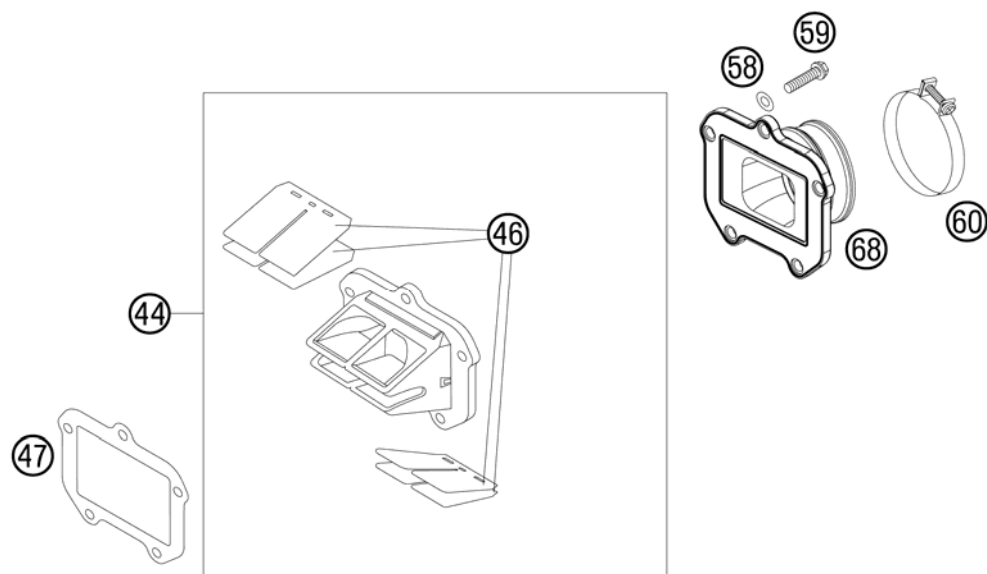

FIG	PART NUMBER	DESCRIPTION	QTY
44	50330051444	REED VALVE ASSY V-FORCE3 06	1
46	50330052244	RED VALVE-SET V-FORCE 3 06	1
47	50330098050	GASKET REED V.PLATE V-FORCE 04	1
58	0137060003	SPRING WASHER DIN0137-B 6	5
59	0025060256	HH COLLAR SCREW M6X25 TX30	5
60	54330061000	CLAMP 52/12 GEMI	1
68	50330050300	INTAKE FLANGE 125 09	1

095033070 / C105033070

* NEW PART

X AS REQUIRED



CRANKSHAFT, PISTON

125 TE 2012

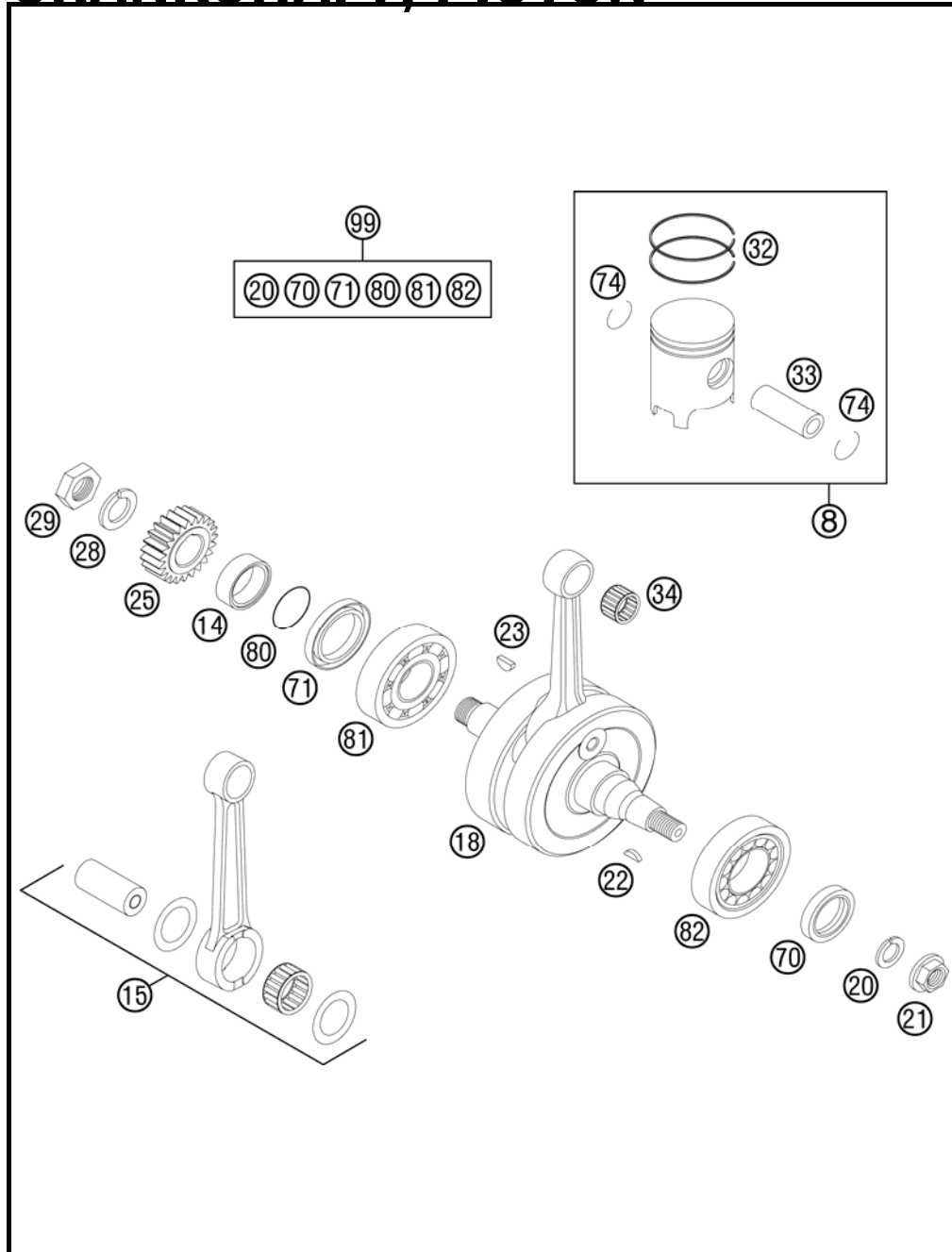

FIG	PART NUMBER	DESCRIPTION	QTY
8	50330207000 I	PISTON I CPL. 125 09	1
8	50330207000 II	PISTON II CPL. 125 09	1
14	54633014100	SPACER BUSHING 12MM	1
15	50330015100	CON.ROD REPAIR KIT 125'07	1
18	50330018300	CRANKSHAFT CPL. 125 EXC 2007	1
20	50230029012	LOCKING RING VSK 12	1
21	49030021000	COLLAR NUT M12X1 R/S	1
22	0888030050	WOODRUFF KEY DIN6888-3X5X13	1
23	6946005	WOODRUFF KEY 5X6,5 HARDED	1
25	50332023123	PRIMARY PINION 23-T 125/200 06	1
28	50230029016	LOCKING RING VSK 16	1
29	50330029000	HEXAGON NUT M 16 X 1,5 - L/S	1
32	50330032600	TRAPEZOID RING 125 2008	x
33	50330033500	PISTON PIN 15X45,2 125 2001	1
34	51030034000	NEEDLE BEARING KBK 15X19X20	1
70	0760253570	SHAFT SEAL RING 25X35X7 BTSL	1
71	0760324564	SHAFT SEAL RING 32X45X6,5 BT	1
74	50330074500	WIRE LOCK RING 15X1	2
80	0770250020	O-RING 25,00X2,00 NBR 70	1
81	0625063055	BALL BEARING 6305 JR2 CS36	1
82	50330082000	CYL.ROLLER BEAR.NJ206 ET2XCS46	1
99	00050002300	CRANKSHAFT REP. KIT 125-200	x

115033060 / C115033061

* NEW PART

X AS REQUIRED



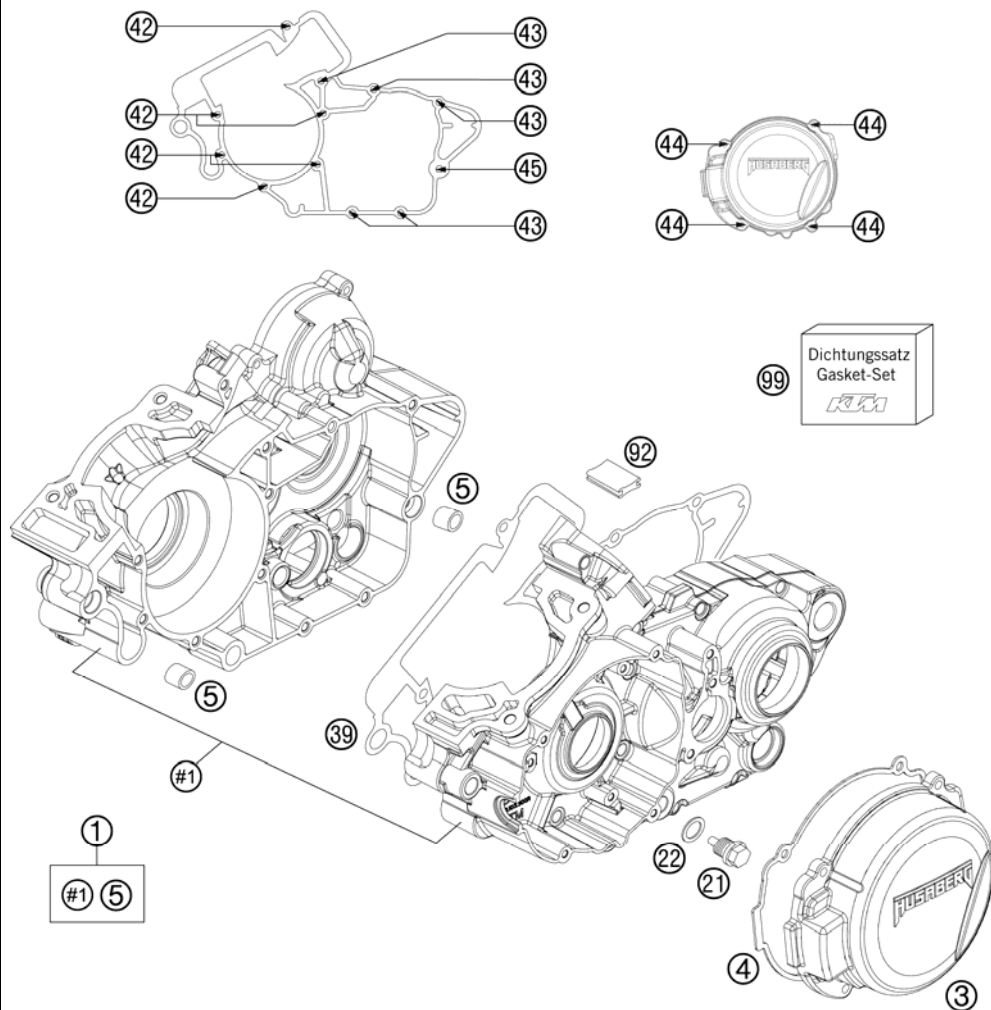

FIG	PART NUMBER	DESCRIPTION	QTY
1	5153000044	ENGINE CASE CPL W.TRAN.BEAR.07	1
3	5033050230089	IGNITION COVER 125 TE 12	1
4	50330040100	IGNITION COVER GASKET 2001	1
5	54630027000	DOWEL BUSHING 13,8X11X12	2
21	58030021000	OILDRAIN PLUG W.MAG. M 12X1,5	1
22	58038022000	CU-SEAL RING DIN7603-12X18X1,5	1
39	50330039000	ENGINE CASE GASKET 0,5MM '98	1
42	0025060506	HH COLLAR SCREW M6X50 TX30	6
43	0025060556	HH COLLAR SCREW M6X55 TX30	5
44	0014050163	HH COLLAR SCREW M 5X16 WS=6	4
45	0025060606	HH COLLAR SCREW M6X60 TX30	1
92	50330092000	OIL GUARD GROMMET 25X31 '98	1
99	50330099200	GASKET KIT 125 07	1

125033010 / C125033011

* NEW PART

X AS REQUIRED

CLUTCH COVER

125 TE 2012

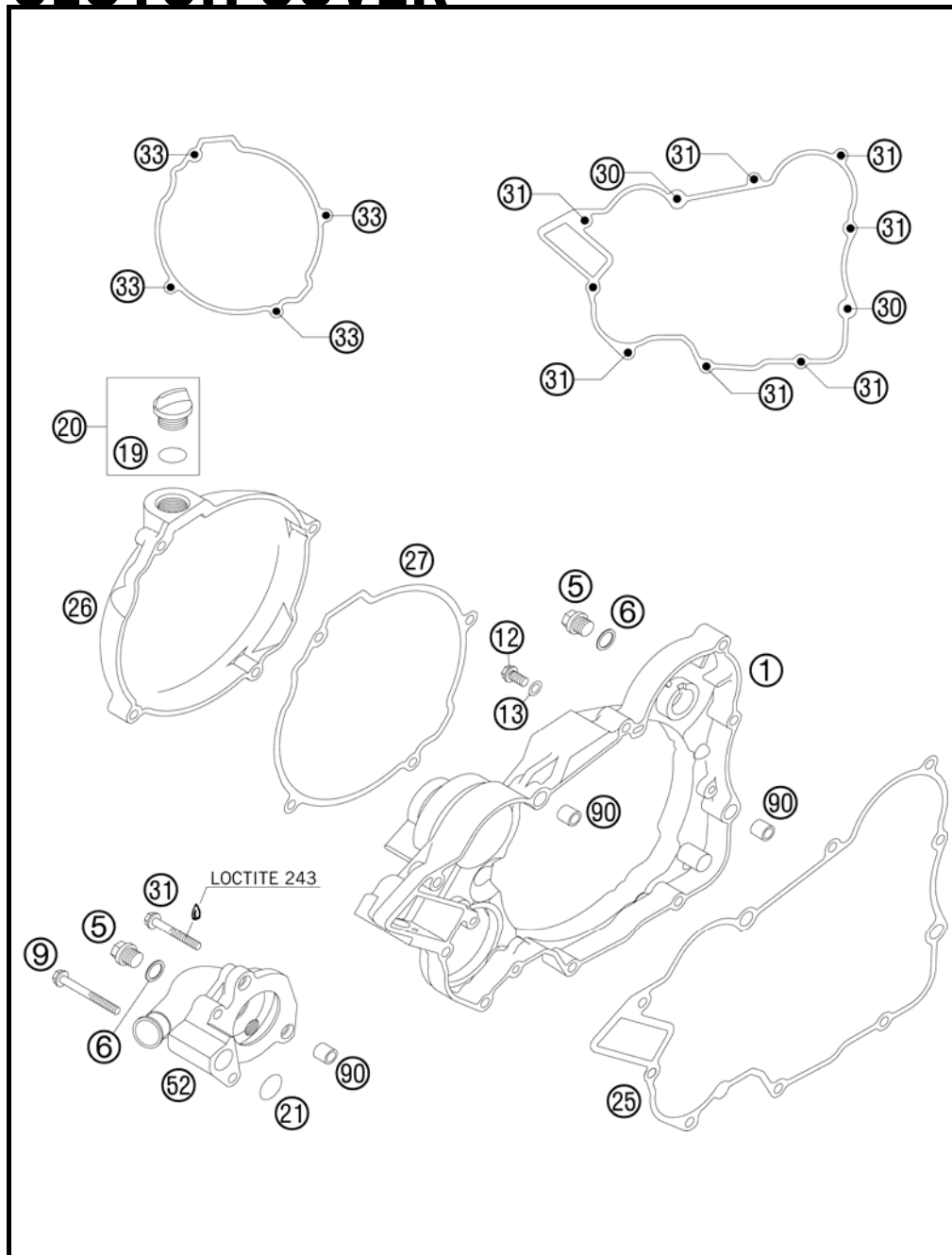

FIG	PART NUMBER	DESCRIPTION	QTY
1	5033000114415	CLUTCH COVER CPL. 125/200 '09	1
5	0910100003	PLUG DIN0910-M 10X1	2
6	0603100141	COPPER GASKET DIN7603-10X14X1	2
9	0025060506	HH COLLAR SCREW M6X50 TX30	2
12	0025060126	HH COLLAR SCREW M6X12 TX30	1
13	0603061001	CU-SEAL RING DIN7603-6X10X1	1
19	0770191015	O-RING 19,00X3,00 NBR	1
20	58030120000	OIL FILLER CAP M24x3 WITH O-R	1
21	0770160030	O-RING 16,00X3,00 NBR 70	1
25	50330025000	CLUTCH COVER GASKET 0,5MM	1
26	5033052620089	CLUTCH COVER 125 TE 12	1
27	50330027000	CLUTCH OUTS.COVER GASKET 1MM	1
30	0025060406	HH COLLAR SCREW M6X40 TX30	2
31	0025060356	HH COLLAR SCREW M6X35 TX30	9
33	0025060306	HH COLLAR SCREW M6X30 TX30	4
52	50335052000	WATER PUMP COVER 125/200 '98	1
90	49030090000	DOWEL 9,8 X 7 X 10	4

095033020 / C125033020

* NEW PART

X AS REQUIRED



ACHTUNG !!!
Vor dem Einbau des Vergasers,
Bedüsung kontrollieren.

CAUTION !!!
Before mounting the carburetor,
check the jetting.

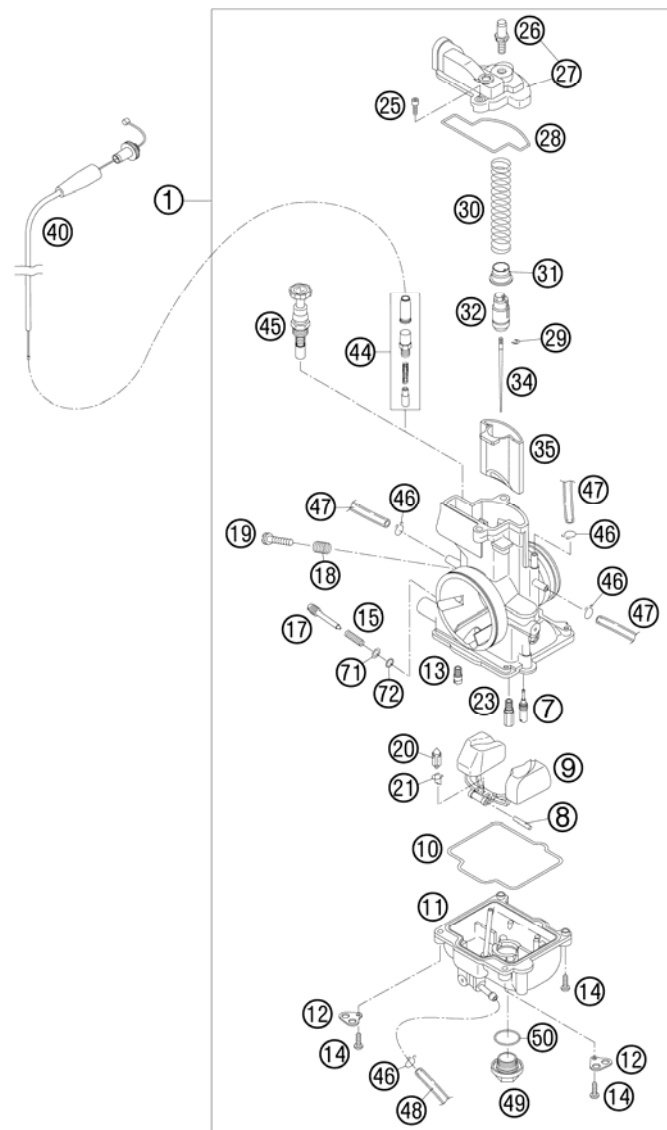

FIG	PART NUMBER	DESCRIPTION	QTY
1	50331101344	CARBURETOR KEIHIN PWK 36S AG06	X
7	54531607035	IDLE JET 35 KEIHIN	X
7	54531607038	IDLE JET 38 KEIHIN	X
7	54531607040	IDLE JET 40 KEIHIN	X
7	54531607042	IDLE JET 42 KEIHIN	X
7	54531607045	IDLE JET 45 KEIHIN	X
7	54531607048	IDLE JET 48 KEIHIN	X
7	54531607050	IDLE JET 50 KEIHIN	X
7	54531607052	IDLE JET 52 KEIHIN	X
7	54531607055	IDLE JET 55 KEIHIN	X
7	54831007138	IDLE JET SIZE 38X38 KEIHIN	X
8	57331008000	ARM PIN FLOAT	1
9	57331009000	FLOAT CPL.	1
10	54831010000	GASKET FLOAT CHAMBER	1
11	54831011000	FLOAT CHAMBER PWK38-S AG	1
12	54531612100	RETAINING PLATE FOR BLEEDER	2
13	54831051050	STARTER JET 50 KEIHIN	X
13	54831051085	STARTER JET 85 KEIHIN	X
14	0016040163	HH COLLAR SCREW M 4X16 WS=6	4
15	54531615000	SPRING FOR ADJUSTMENT SCREW	1
17	54531617000	ADJUSTMENT SCREW	1
18	54631118000	SPRING	1
19	54631219100	ADJUSTMENT SCREW M 5	1
20	54631220000	FLOAT NEEDLE	1
21	54531621000	CLAMP	1
23	54531623140	MAIN JET GR 140	X
23	54531623155	MAIN JET 155 KEIHIN	X
23	54531623158	MAIN JET 158 KEIHIN	X
23	54531623160	MAIN JET 160 KEIHIN	X
23	54531623162	MAIN JET 162 KEIHIN	X
23	54531623165	MAIN JET 165 KEIHIN	X
23	54531623168	MAIN JET 168 KEIHIN	X
23	54531623170	MAIN JET 170 KEIHIN	X
23	54531623172	MAIN JET 172 KEIHIN	X
23	54531623175	MAIN JET 175 KEIHIN	X

085033110 / C115033110

* NEW PART

X AS REQUIRED

ACHTUNG !!!
Vor dem Einbau des Vergasers, Bedüsung kontrollieren.

CAUTION !!!
Before mounting the carburetor, check the jetting.

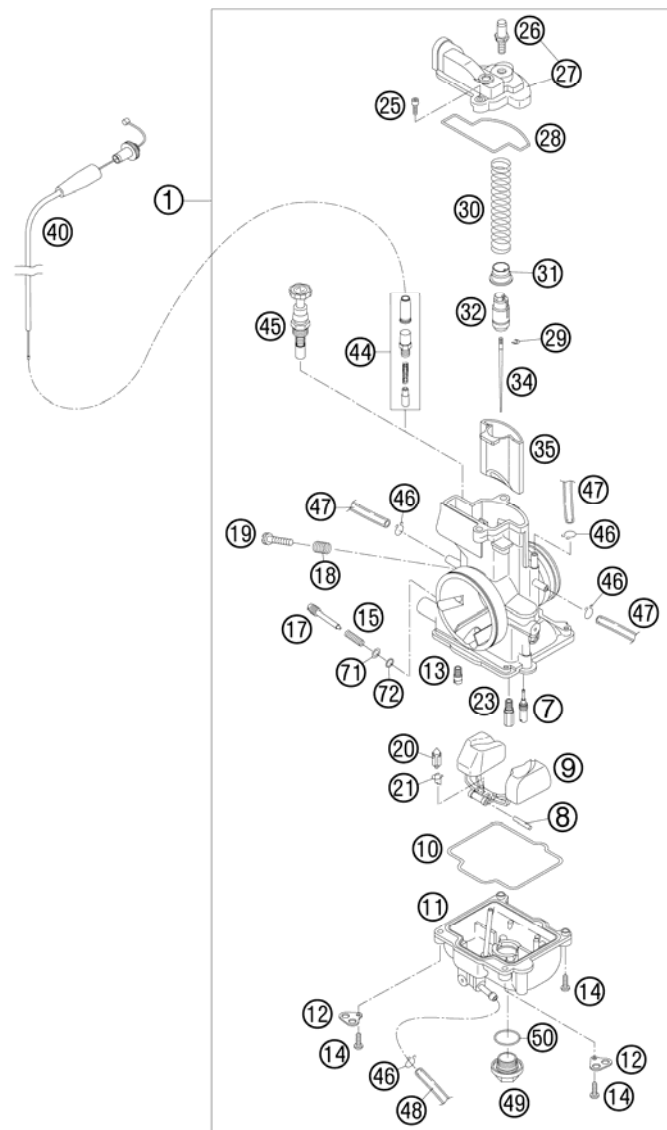

FIG	PART NUMBER	DESCRIPTION	QTY
23	54531623178	MAIN JET 178 KEIHIN	x
23	54531623180	MAIN JET 180 KEIHIN	x
23	54531623182	MAIN JET 182 KEIHIN	x
23	54531623185	MAIN JET 185 KEIHIN	x
25	54831025000	SPECIAL-AH-SCREW M 4X12	2
26	54831029000	THROTTLE CALBE HOLDER M6X0,75	1
27	54831127000	CARBURETOR COVER PWK36-S AG	1
28	54831028000	GASKET FOR CARBURETOR COVER	1
29	54531629000	CLIP FOR JET NEEDLE	1
30	54831030000	SLIDING SPRING	1
31	54631231000	SPRING CAP	1
32	54631232000	NIPPLE	1
34	54531636003	JET NEEDLE NOZ C KEIHIN	x
34	54531636004	JET NEEDLE NOZ D KEIHIN	x
34	54531636005	JET NEEDLE NOZ E KEIHIN	x
34	54531636006	JET NEEDLE NOZ F KEIHIN	x
34	54531636007	JET NEEDLE NOZ G KEIHIN	x
34	54531636008	JET NEEDLE NOZ H KEIHIN	x
34	54531636009	JET NEEDLE NOZ I KEIHIN	x
34	54831034000	JET NEEDLE KEIHIN N84I	x
35	54631035000	THROTTLE VALVE 7 FOR 38 PJ '00	1
40	54831078000	CABLE F. COLD START ACT. 08	1
44	58502096044	CONNECT. COLD START CABLE CPL.	1
45	54631245000	STARTER PISTON CPL.	x
46	54531696000	CLAMP 6 MM	5
47	31007007101	PVC-HOSE 4X6MM	2
48	52031137001	PVC-HOSE 3X5MM	x
49	54531699000	PLUG M 18X1	1
50	0770180230	O-RING 18,00X2,30 NBR 70	1
71	54831071000	WASHER ADJUSTING SCREW	1
72	54831072000	O-RING ADJUSTING SCREW	1

085033110 / C115033110

* NEW PART

X AS REQUIRED

ACHTUNG !!!
Bei Bestellung von 1 Stk. 50332011000 bzw. 50332011100 werden 7 Stk. 77032011000 ausgeliefert, da die Belaglamellen nicht untereinander getauscht werden dürfen!

CAUTION !!!
When ordering 1 piece of 50332011000 or 50332011100, 7 pieces of 77032011000 will be delivered because the lining disc must not be changed among themselves!

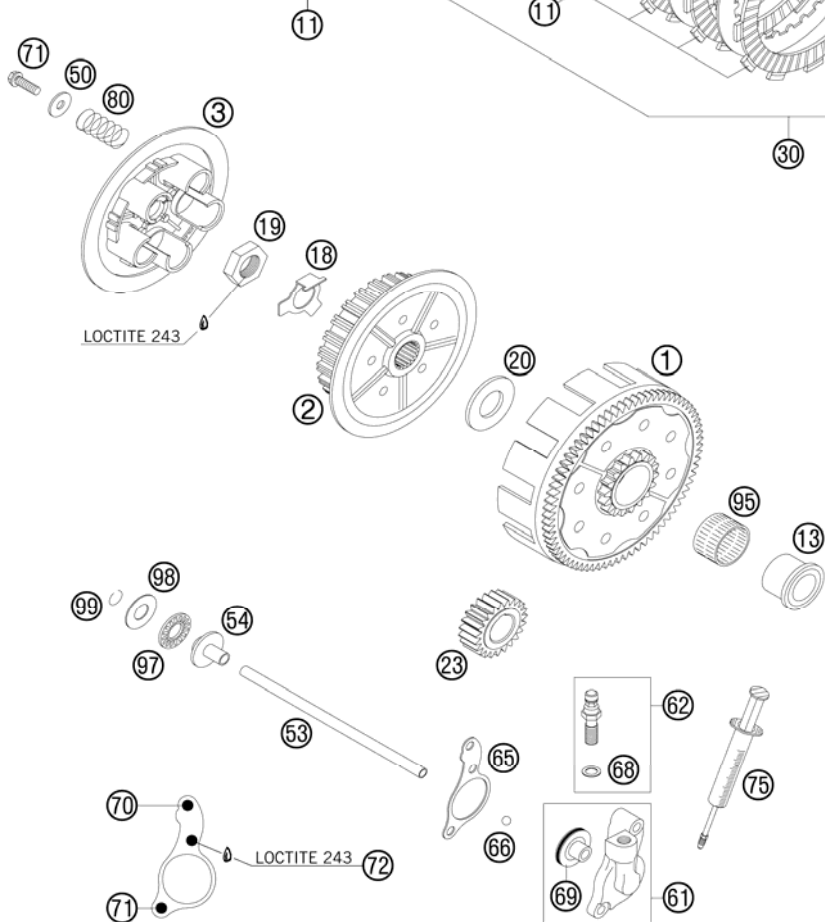
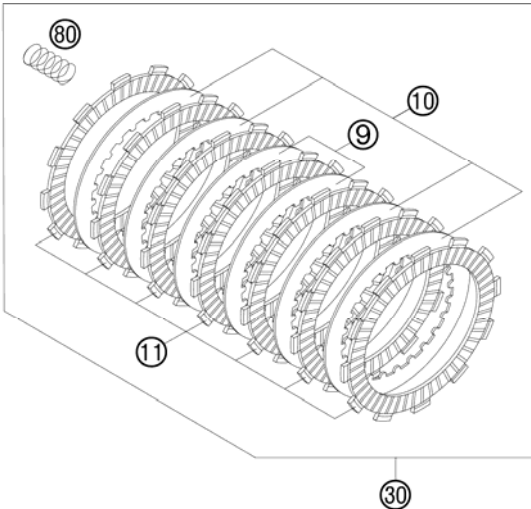

FIG	PART NUMBER	DESCRIPTION	QTY
1	50332000073	OUTER CLUTCH H.73-T 125/200 WITHOUT PRIMARY PINION	1
2	50332002000	INNER CLUTCH HUB 125/200'98	1
3	50332003100	PRESSURE PLATE 1257200 06	1
9	50332010100	INTERMEDI. DISC STEEL 1,5MM'98	2
10	50332010400	INTERMEDIATE DISC 1,5MM	4
11	77032011000	LINING DISC 3,0MM 05	7
13	50332013000	INNER RING 20X26X25,9 '98	1
18	50332018000	SHEET METAL LOCK 1,5MM '98	1
19	0936181505	HEXAGON NUT DIN0936-M18X1,5 R.	1
20	50332020000	STOP DISK 20X39,6X3 '98	1
23	50332023023	PRIM. PINION 23-T 125/200'98	1
30	50332010110	% CLUTCH KIT 200 EXC 09-11	1
50	50232050000	WASHER 6,2X18X2	5
53	50332017300	PUSH ROD L=178 125/200 2006	1
54	50332054051	PRESSURE PIECE 125-380 '98	1
61	50332061044	CYLINDER CPL. 125/200'98	1
62	50332062000	HOLLOW SCREW CPL. M 10X1 '98	1
65	50332065051	CLUTCH RELEASE GASKET 0,3MM	x
65	50332065052	CLUTCH RELEASE GASKET 0,5MM	x
65	50332065053	CLUTCH RELEASE GASKET 0,75MM	x
66	0401070003	BALL DIN5401-7	1
68	42013226000	CU-SEAL RING DIN7603-10X16X1	1
69	50332066000	PISTON W. O-RING 125/200 2000	1
70	0025060406	HH COLLAR SCREW M6X40 TX30	1
71	0025060206	HH COLLAR SCREW M6X20 TX30	6
72	0025060256	HH COLLAR SCREW M6X25 TX30	1
75	50329050000	VENT INJEKTION HYDR. CLUTCH	1
80	52332005000	CLUTCH SPRING 2,4X40 200'98	5
95	56532095000	NEEDLE BEARING K26X30X22ZW.KSE	1
97	54637097200	AXIAL NEEDLE BEARING AXK 1226	1
98	54637098200	AXIAL WASHER AS1226 12X26X1	1
98	54637098300	AXIAL WASHER 12,5X25,8X1,5	x
99	0993012000	CIRCLIP DIN7993-RW12	1

085033211 / C125033211

* NEW PART

X AS REQUIRED



TRANSMISSION I - MAIN SHAFT

125 TE 2012

ACHTUNG !!!
 Bei Bestellung von Getrieberädern, Markierung beachten.
CAUTION !!!
 When ordering transmission gears, check marking.

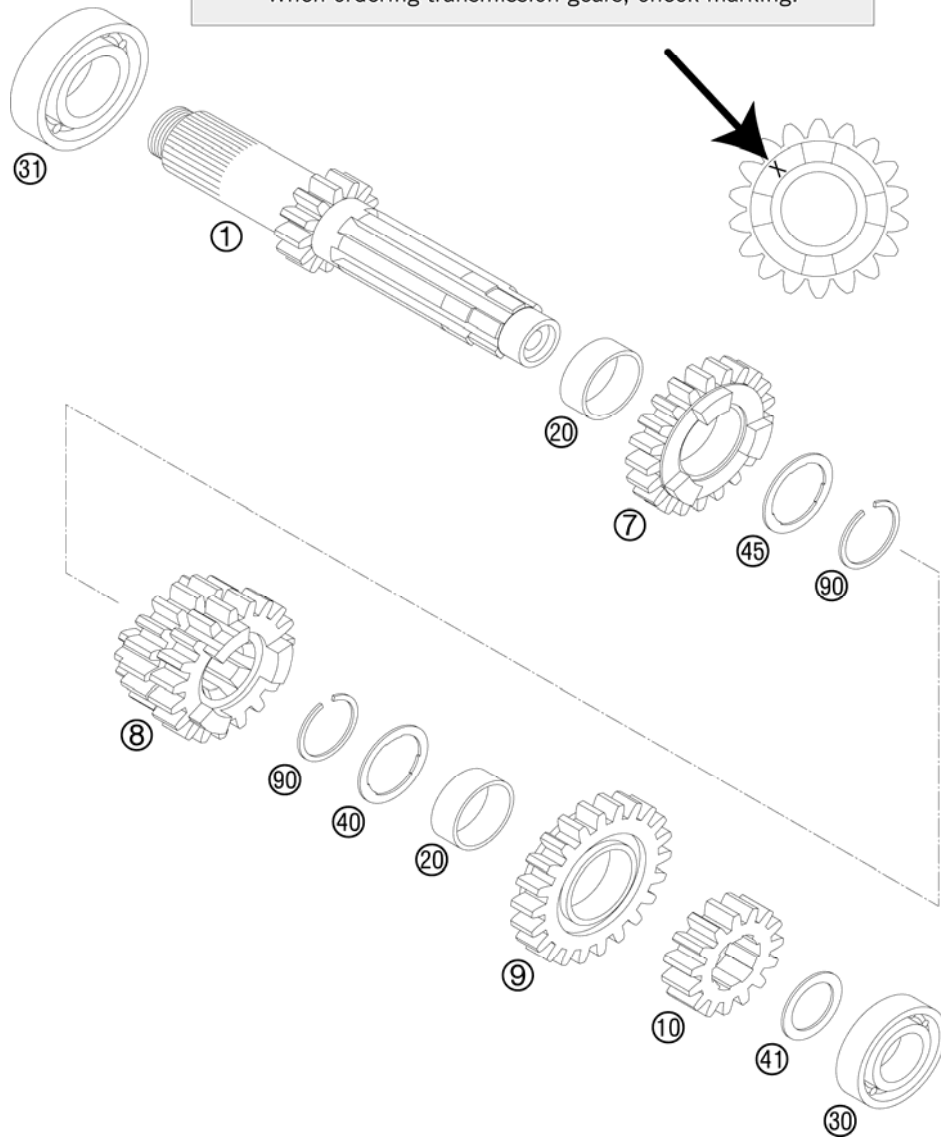

FIG	PART NUMBER	DESCRIPTION	QTY
1	50333001144	MAIN SHAFT CPL. 12-T '98	1
7	50333007000	IDLER G.5TH G.21-T "5S21" '98	1
8	50333008100	SLIDING GEAR 3/4.G. 17/19-T 04 "3S17H"- "4S19H"	1
9	50333009100	IDLER G.6TH G.20-T "6G20" '98	1
10	50333010100	SOLID GEAR 2ND G.15-T"2S15" 03	1
20	50333020000	IDLER GEAR BUSH. 22X25X11,1 A	2
30	0625160031	GROOVED BALL B. 16003 C4 J1	1
31	0625060042	BALL BEARING 6004 TN9 C4	1
40	50333040000	STOP DISC 22,2X27,8X1 A	1
41	50333041000	STOP DISC 17,2X26X1 B	1
45	50333045000	STOP DISK 22,2X27,8X1	1
90	50133090000	LOCK RING 22X1,2	2

085033330 / C085033331

* NEW PART

X AS REQUIRED



TRANSMISSION II - COUNTERSHAFT

125 TE 2012

ACHTUNG !!!
Bei Bestellung von Getrieberädern, Markierung beachten.
CAUTION !!!
When ordering transmission gears, check marking.

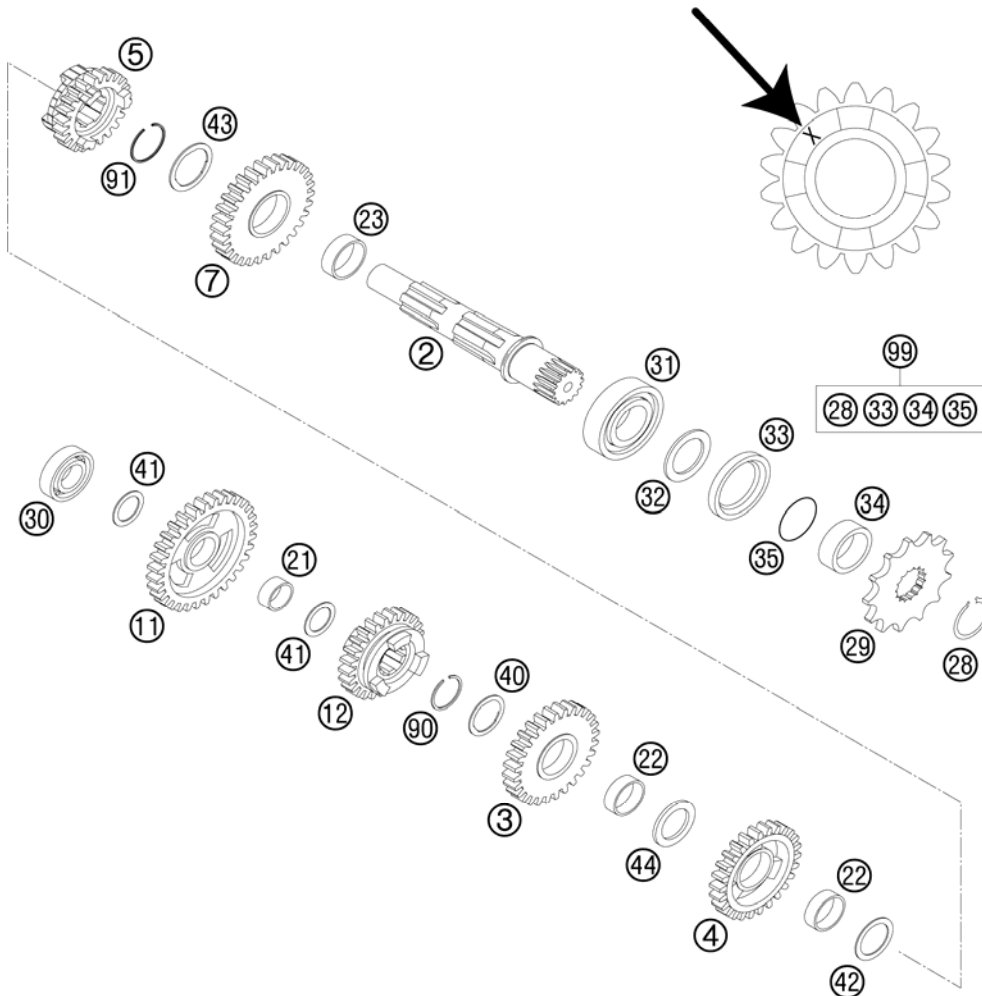

FIG	PART NUMBER	DESCRIPTION	QTY
2	50333002000	COUNTER SHAFT 125/200 '98	1
3	50333003100	IDLE G.3RD G.28-T "3S28H" 04	1
4	50333004000	IDLE G.4TH G.26-T "4S26" '98	1
5	50333005100	SLIDING G.6TH G.20-T "6G20"'98	1
7	50333006100	IDLER G. 2ND G. 31-T "2G31"'98	1
11	50333011300	IDLER G. 1ST G. 33-T "1G33"'98	1
12	50333012000	SLIDING G.5TH G.25-T "5S25"'98	1
21	50333021000	IDLER GEAR BUSHING 17X20X9,7 B	1
22	50333022000	IDLER GEAR BUSHING 22X25X8,1 C	2
23	50333023000	IDLER GEAR BUSHING 25X28X9,7 D	1
28	52033096000	LOCK RING DINO471-25X1,64SD	1
29	50033029013	FRONT SPROCKET 13-T	x
29	50033029014	FRONT SPROCKET 14-T	x
30	0625060031	BALL BEARING 6003 TN9 C4	1
31	0625062058	BALL BEARING 6205 TN9 C3	1
32	56033020000	STOP RING	1
33	0760324571	SHAFT SEAL RING 32X45X7 BSLNBR	1
34	54633014100	SPACER BUSHING 12MM	1
35	0770230020	O-RING 23,00X2,00 NBR70	1
40	50333040000	STOP DISC 22,2X27,8X1 A	1
41	50333041000	STOP DISC 17,2X26X1 B	2
42	50333042000	STOP DISK 22,2X28X1 C	1
43	50333043000	STOP DISC 25,2X32X1	1
44	50333044000	STOP DISC 22,2X30X2,5	1
90	50133090000	LOCK RING 22X1,2	1
91	52033090100	LOCK RING 25X1,2	1
99	00050000943	COUNTER SHAFT REP.KIT 125-200	x

085033360 / C085033361

* NEW PART

X AS REQUIRED



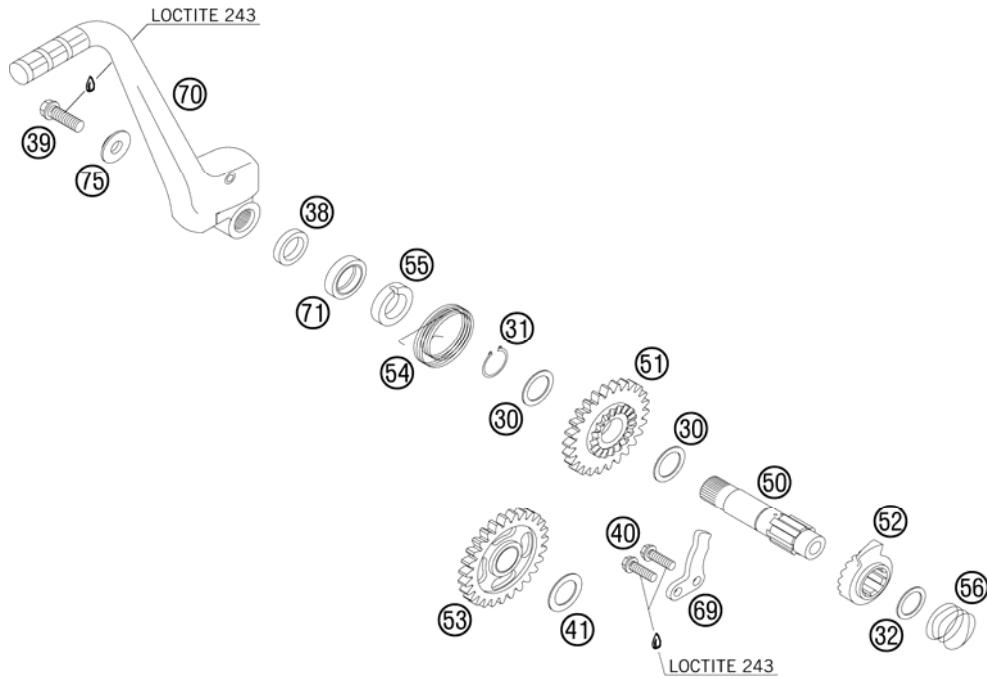

FIG	PART NUMBER	DESCRIPTION	QTY
30	50333030000	STOP DISK 17,2X24X1	2
31	0471170010	CIRCLIP DIN0471-17X1	1
32	0988162210	THRUST WASHER DIN0988-16X22X1	1
38	50333038100	SPACER BUSHING 16X23X26X6,1	1
39	0025080206	HH COLLAR SCREW M8X20 TX40	1
40	0025060166	HH COLLAR SCREW M6X16 TX30	2
41	50333041000	STOP DISC 17,2X26X1 B	1
50	50333050000	KICKSTARTER SHAFT 125/200'98	1
51	50333051026	KICKSTART.GEAR 26-T 125/200'98	1
52	50333052000	KICKSTARTER RATCHET	1
53	50333053127	INTERMEDIATE GEAR 27-T 04	1
54	50333054000	KICKSTARTER SPRING 2,6MM '98	1
55	50333055000	DRIVING HUB 125/200'98	1
56	50333056000	SPRING 1,4MM '98	1
69	50333069000	STOP MET.SHEET 4MM 125/200'98	1
70	50333070244	KICK STARTER CPL.	1
71	0760172870	SHAFT SEAL RING 17X28X7 B	1
75	50333075000	WASHER 8,2X22X4,5 '98	1

085033390 / C125033392

* NEW PART

X AS REQUIRED



SHIFTING MECHANISM

125 TE 2012

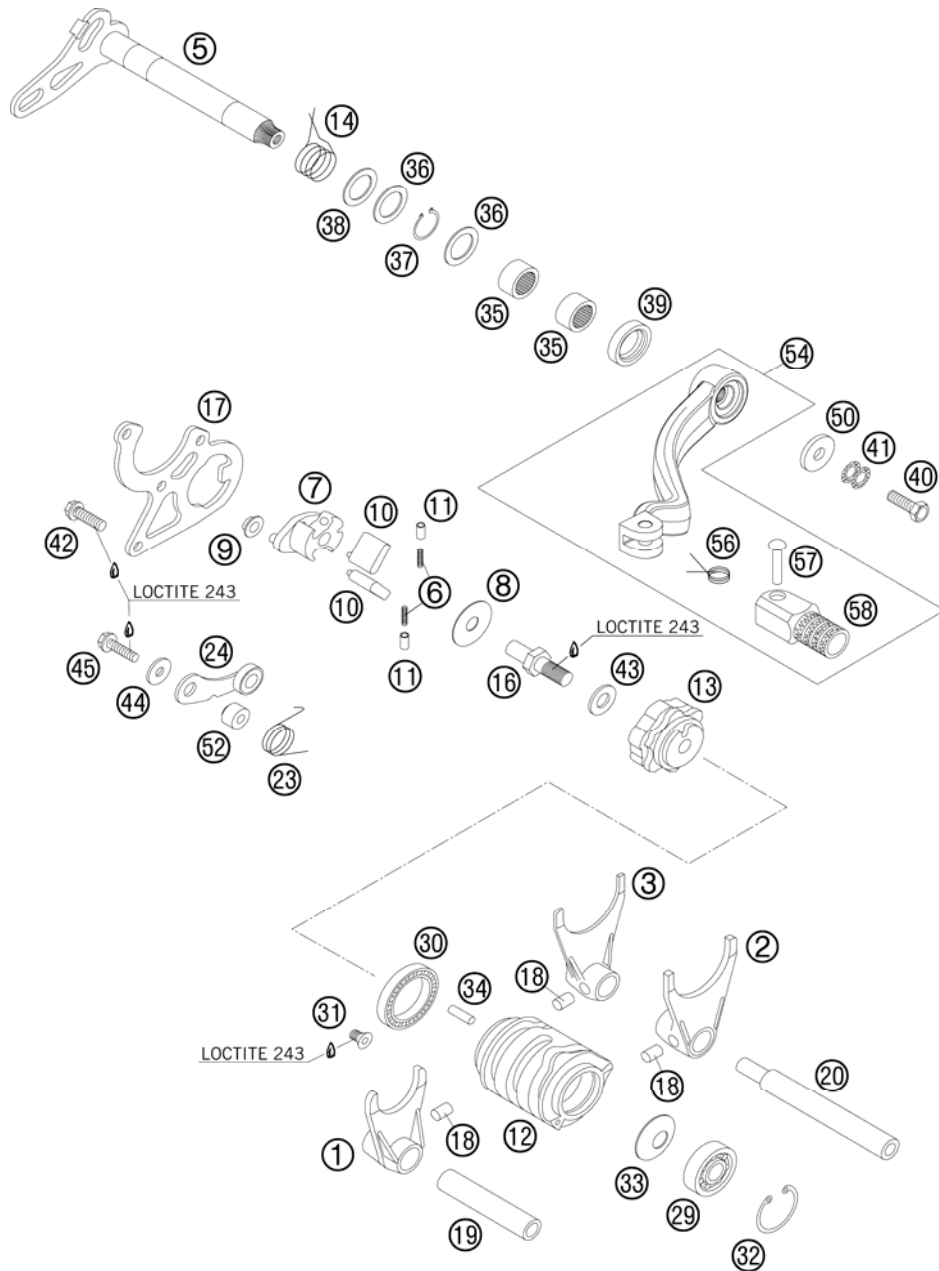

FIG	PART NUMBER	DESCRIPTION	QTY
1	50334001200	SHIFTING FORK 5TH/6TH GEAR	1
2	50334002200	SHIFTING FORK 2ND/4TH GEAR	1
3	50334003200	SHIFTING FORK 1ST/3RD GEAR	1
5	50334005000	SHIFTING SHAFT 125/200'98	1
6	50334007052	SPRING FOR RATCHET 0,5X11,5	2
7	50334007000	RATCHET SUPPORT 125/200'98	1
8	50334007054	STOP DISK 8,2X26X0,7	1
9	50334007053	BUSHING 6X8X12X4,5	1
10	50334007050	SHIFTING RATCHET 125/200'98	2
11	50334007051	PRESSURE END PAD 4,1X5,6X8,4	2
12	50334012300	SHIFTING DRUM 06	1
13	50334013000	LOCATING DRUM 125/200'98	1
14	50334014000	RETURN SPRING 3MM	1
16	50334016000	SPECIAL SCREW M8X21,5 WS=12	1
17	50334017000	SHIFTING GATE 3MM 125/200'98	1
18	0402061000	NEEDLE ROLLER ZRB 6X10	3
19	50334019000	SHIFTING ROD DRIVE 11,8X67,5	1
20	50334020000	SHIFT. ROD DRIVE END 11,8X94,5	1
23	50334023000	LOCATING LEVER SPRING 2,5MM'98	1
24	50334024144	LOCATING LEVER CPL. 08	1
29	0625060006	BALL BEARING 6000 RS1 C3	1
30	0625618050	BALL BEARING 61805 C3	1
31	0991050102	FLAT H.SCEW DIN7991-M5X10 10.9	1
32	0472260120	LOCK RING DIN0472-26X1,2	1
33	0093251209	SPRING WASHER 12,2X25X0,9	1
34	0402040980	NEEDLE ROL.DIN5402 NRB 4X9,8	1
35	54632095000	NEEDLE BEAR.HK 1412 14X20X12	2
36	49033031000	STOP DISK 14,3X20X1	2
37	0471140100	LOCK WASHER DIN0471-14X1	1
38	49033031015	STOP DISK 14,2X22X1,5	1
39	0760142460	SHAFT SEAL RING 14X24X6 B	1
40	59009062016	SPECIAL SCREW M6X16 WS=8 10.9	1
41	50233041000	PAIR OF WASHERS M 6 NORDLOCK	1
42	0025060166	HH COLLAR SCREW M6X16 TX30	3
43	0125080003	WASHER DIN0125-A 8,4	1

085233410 / C095033410

* NEW PART

X AS REQUIRED



SHIFTING MECHANISM

125 TE 2012

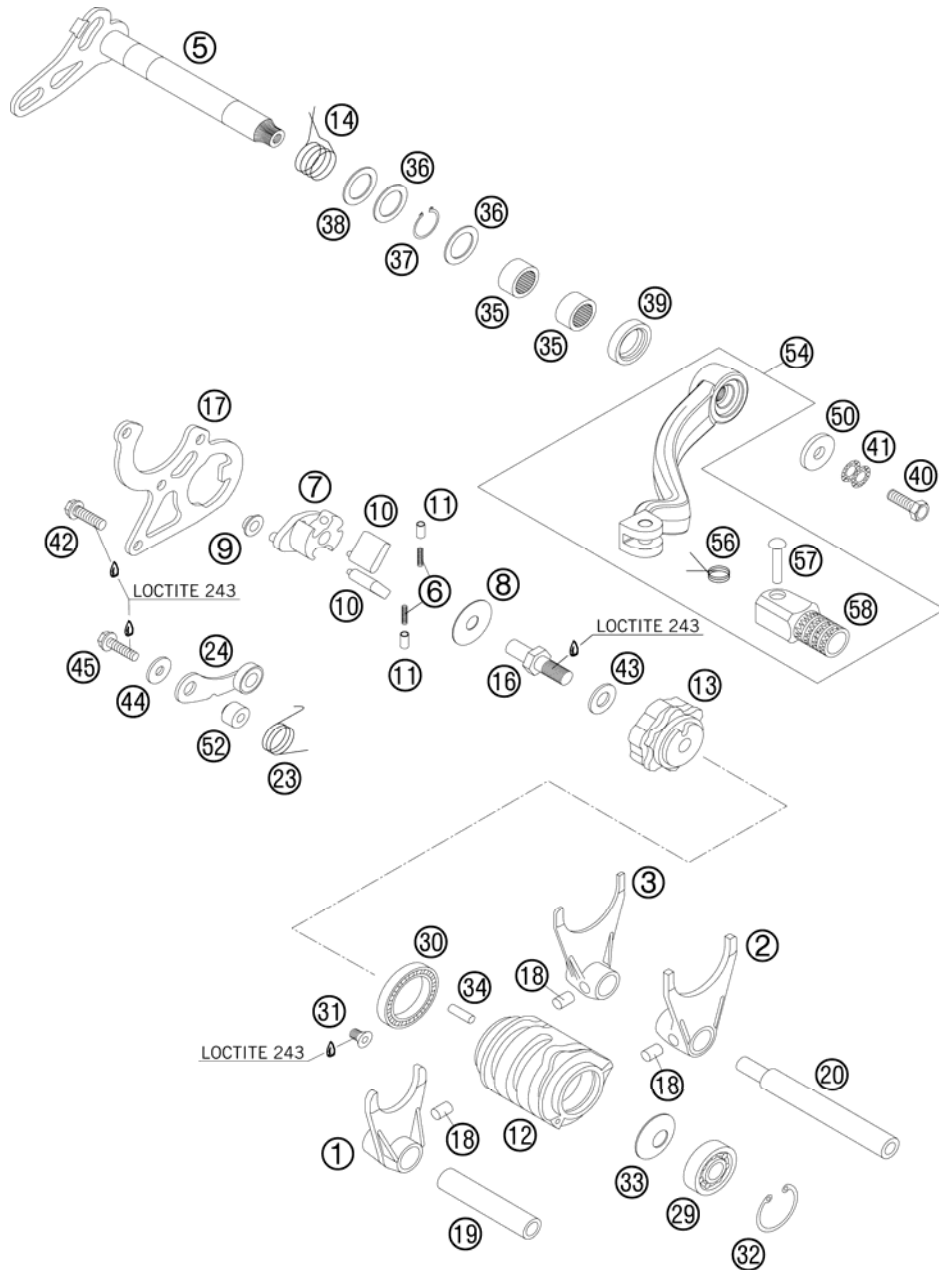

FIG	PART NUMBER	DESCRIPTION	QTY
44	0349000050	WASHER DIN7349-5X15X2	1
45	0025050206	HH COLLAR SCREW M5X20 TX30	1
50	50232050001	STEEL WASHER 6,4X17X3	1
52	54634052300	SLEEVE FOR LOCKING LEVER	1
54	54734031000	SHIFT LEVER CPL. 2-STROKE 2001	1
56	54634032100	SHIFTING LEVER SPRING 250	1
57	54634031050	BOLT 6X25 FOR SHIFT LEVER	1
58	54634131000	STEP PLATE FOR SHIFT LEVER 250	1

085233410 / C095033410

* NEW PART

X AS REQUIRED



COOLING SYSTEM

125 TE 2012

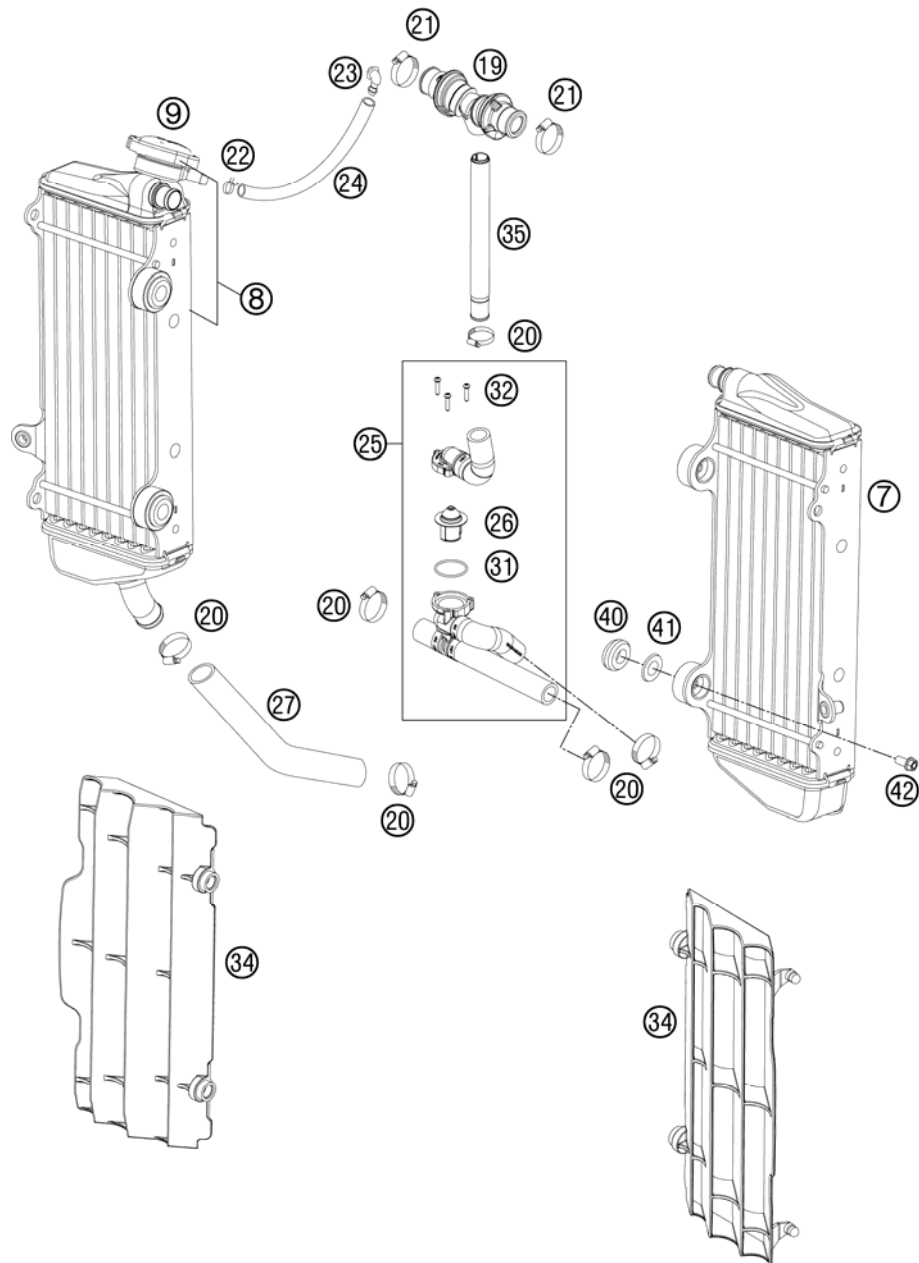

FIG	PART NUMBER	DESCRIPTION	QTY
7	54835007300	RADIATOR L/S "55562"	11
8	54835008400	RADIATOR R/S "55620"	11
9	77335016000	RADIATOR CAP SMALL 1,8 BAR	1
19	77235071044	Y-CONNECOTOR CPL.	1
20	10001020000	HOSE CLAMP GEMI 16-27	6
21	42013037400	HOSE CLAMP NORMA 12/24	2
22	45031005000	YDNAC-CLAMP FUEL HOSE (8MM)	1
23	50303089000	ANGLE PIECE '97	1
24	50335030001	PVC-HOSE 6X9	x
25	50335426033	RADIATOR H. 125 W. THERM.55 08	1
26	54835017000	THERMOSTAT 55°C 2004	1
27	50335027000	RADIATOR HOSE 18X25 125/200'98	1
31	0770320020	O-RING 32,00X2,00	1
32	0016040183	SCREW FOR PLASTIC D=4X18	3
34	7733503400030	RADIATOR PROTECTION BLACK 07	2
35	77235073000	HOSE CONNECTOR L=172,5	1
40	41001052000	RUBBER SLEEVE D=12MM	4
41	77335001000	WASHER FOR RADIATOR 08	4
42	0023060123	COLLAR SCREW M6X12 TX	4

125033531 / C125033532

* NEW PART

X AS REQUIRED



EXHAUST CONTROL

125 TE 2012

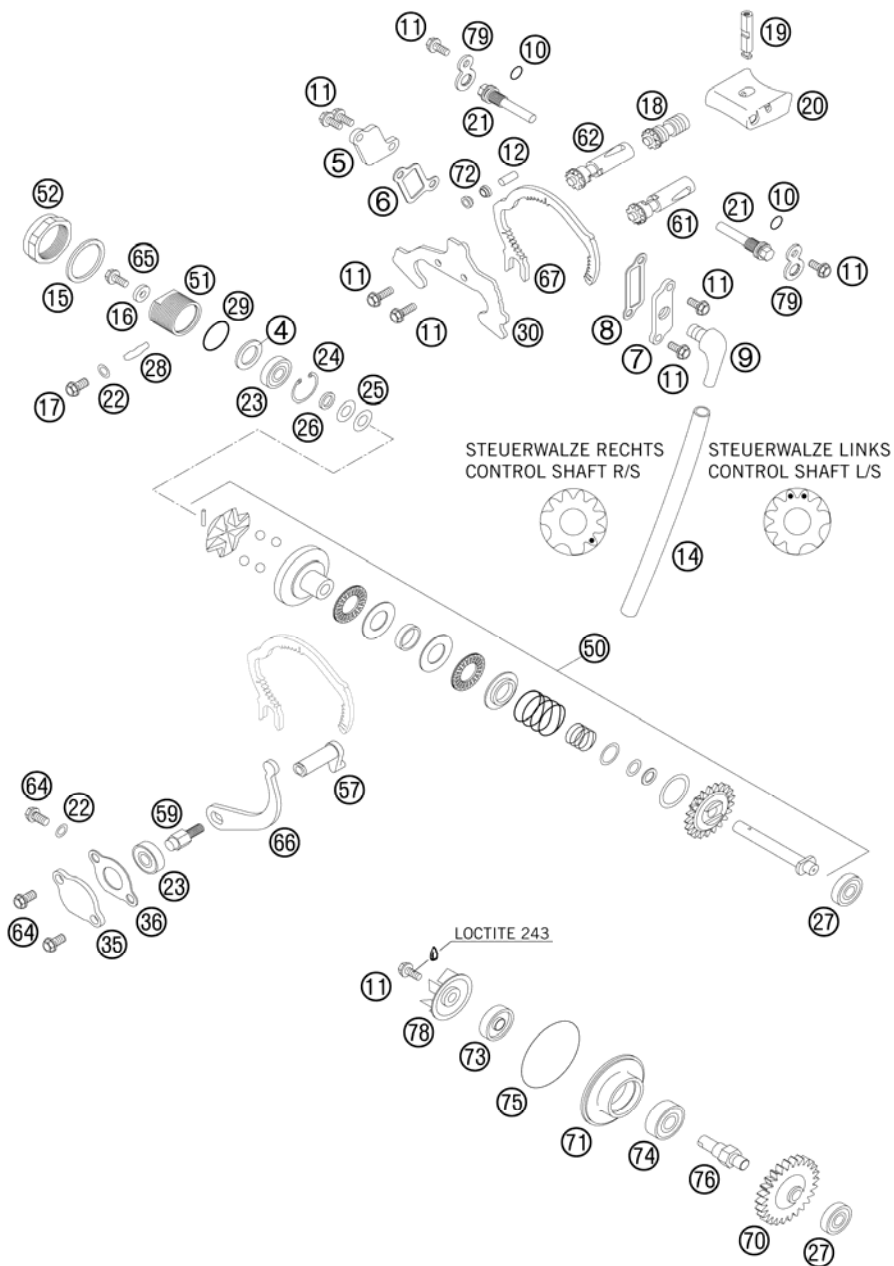

FIG	PART NUMBER	DESCRIPTION	QTY
4	49033031015	STOP DISK 14,2X22X1,5	1
5	50337005100	SIDE COVER R/S 2007	1
6	50337006100	GASKET SIDE COVER R/S 07	1
7	50337007200	SIDE COVER LEFT 2007	1
8	50337008100	GASKET SIDE COVER L/S 07	1
9	50330022000	ANGLE PIEC 90 DEGREE M10X1 02	1
10	0770008020	O-RING 8,00X2,00 NBR	2
11	0014050123	HH COLLAR SCREW M 5X12 WS=6	9
12	0402051600	NEEDLE ROL. DIN5402 NRB 5X15,8	3
14	50332095200	TUBE RUBBER 6X9 DVOH 200MM	1
15	0603262322	CU-SEAL RING DIN7603-26X32X2	1
16	50337050064	WASHER 5,2 X 12 X 3	1
17	0025060106	HH COLLAR SCREW M6X10 TX30	1
18	50337018144	ECCENTRIC FOR CRANKBOLT 125 09	1
19	50337019000	CRANK BOLT F.CONTROL FL.125'98	1
20	50337020544	CONTROL FLAP 125 CPL.	1
21	50337021100	AXLE FOR CONTRIL FLAP 2007	2
22	0603061001	CU-SEAL RING DIN7603-6X10X1	2
23	0625006087	GROOVED BALL BEAR. 608 2RS C3	2
24	0472022100	CIRCLIP DIN0472-22X1	1
25	0093821606	WASHER DIN2093-8,2X16X0,6	2
26	50337050063	SPACER BUSHING 8X12X2,3	1
27	0625006082	BALL BEARING 608 RS C3	2
28	00099300011	O-RINGSTRING 4MM NBR 70 PER/M	x
29	0770160030	O-RING 16,00X3,00 NBR 70	1
30	50337030000	SHEET METAL GUIDE 3MM 125'98	1
35	50337035000	CLOSING COVER '98	1
36	50337035050	CLOSING COVER GASKET 1MM	1
50	50337050044	CENTRIFUGAL TIMER CPL. 125'98	1
51	50337050062	BUSHING HOLDER M 26X1 '98	1
52	50337050061	CLOSING NUT M 26X1 WS=30	1
57	50337057000	CONTROL LEVER 125/200'98	1
59	50337059000	CONTROL SHAFT M 6 WS=10 '98	1
61	50337061144	CONTROL SHAFT CPL.L/S 125 2001	1
62	50337062144	CONTROL SHAFT CPL.R/S 125 2001	1

095033710 / C115033710

* NEW PART

X AS REQUIRED



EXHAUST CONTROL

125 TE 2012

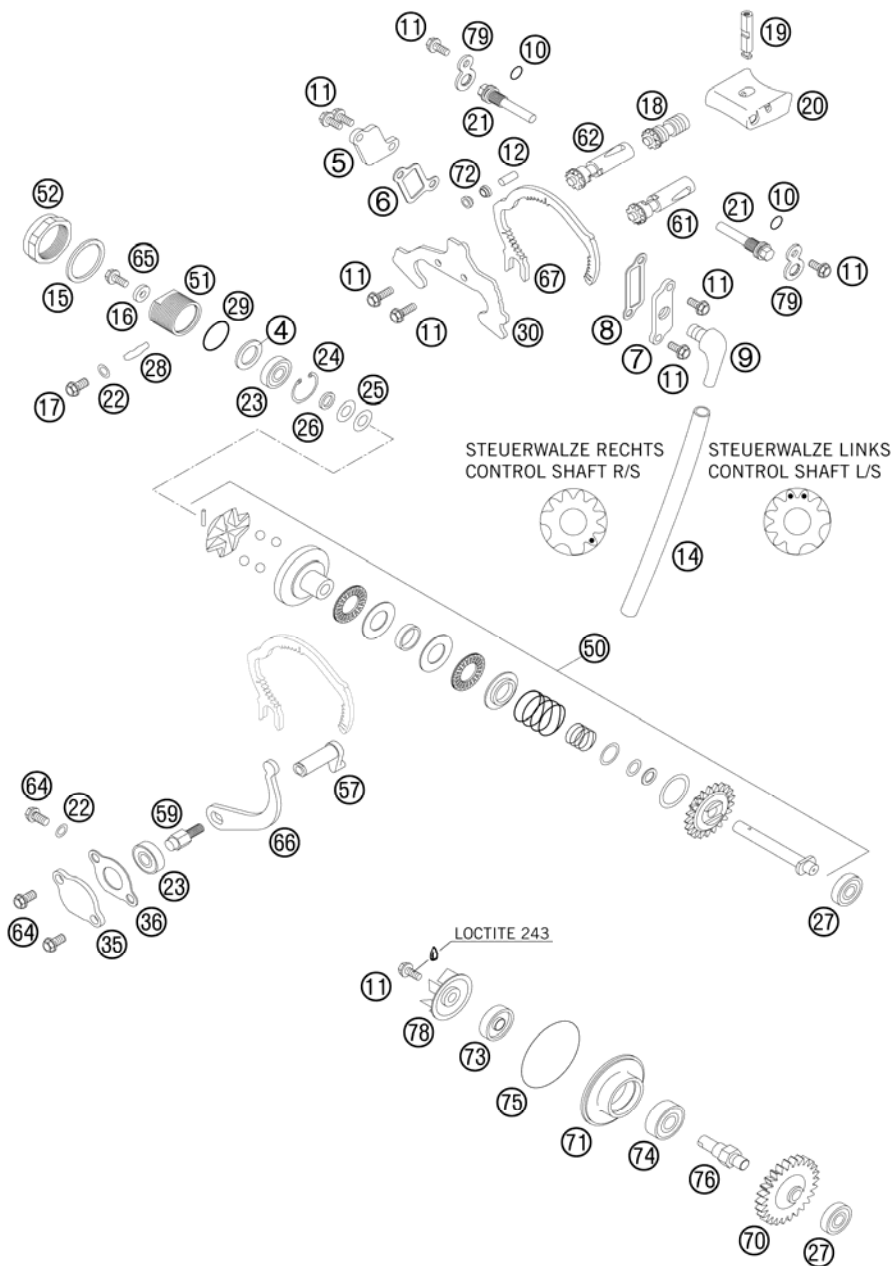

FIG	PART NUMBER	DESCRIPTION	QTY
64	0025060126	HH COLLAR SCREW M6X12 TX30	3
65	0025050126	HH COLLAR SCREW M5X12 TX30	1
66	50337066000	LEVER F. CONTROL SEGMENT '98	1
67	50337067000	CONTROL SHAFT SEGMENT 125'98	1
70	50335054026	DRIVE WHEEL 26-T 125/200'98	1
71	50335056000	BUSHING SUPPORT WATER PUMP '98	1
72	50337072000	ROLLER GUIDE 5X6,1X8X4 '98	6
73	0760082472	SHAFT SEAL RING 8X24X7 A DUO	1
74	0625060001	BALL BEARING 6000/C3	1
75	0770049025	O-RING 49,00X2,50 NBR	1
76	50335054150	WATER PUMP SHAFT	1
78	54835005000	WATER PUMP WHEEL 07	1
79	50337079000	LOCK METAL SHEET 2MM '98	2

095033710 / C115033710

* NEW PART

X AS REQUIRED



IGNITION SYSTEM

125 TE 2012

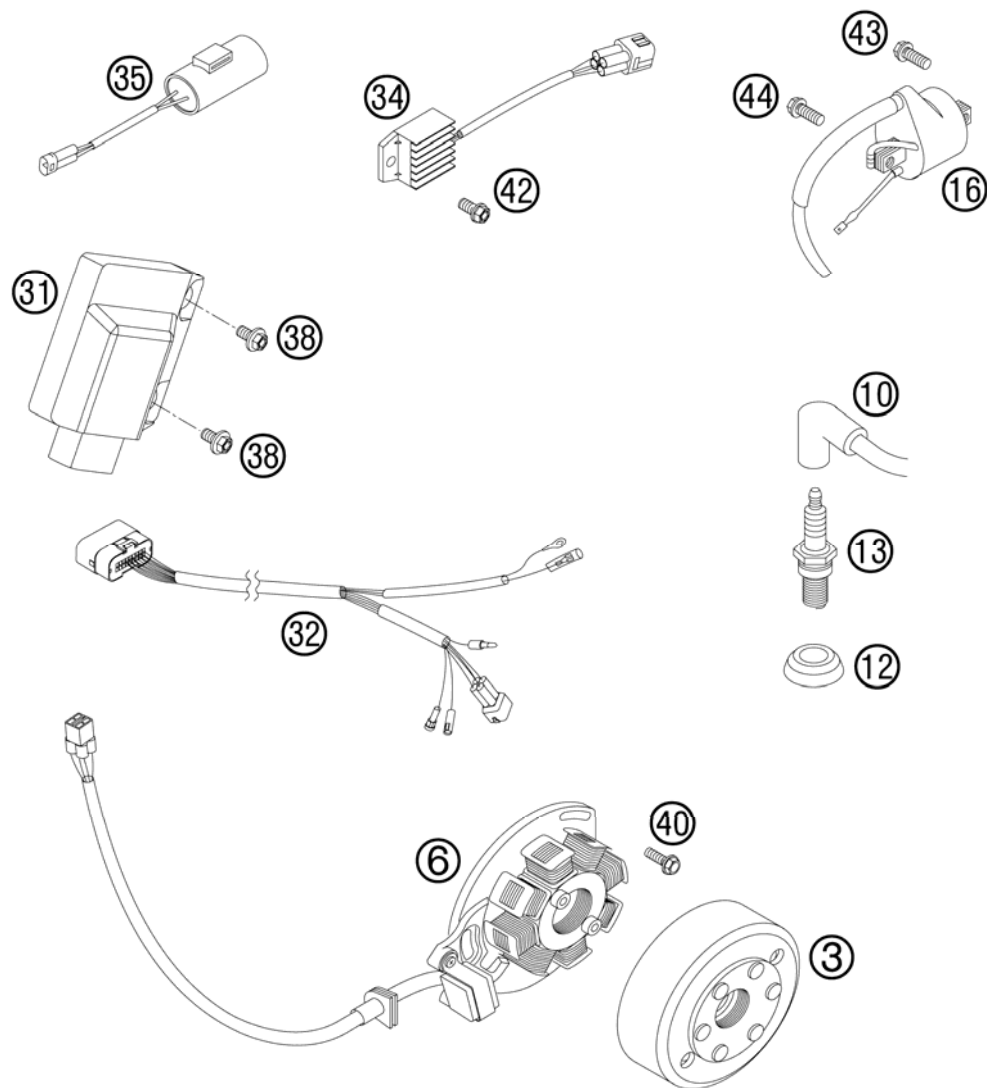

FIG	PART NUMBER	DESCRIPTION	QTY
3	50339005200	FLYWHEEL KOKUSAN 2K-3 '98	1
6	54839204000	STATOR KOKUSAN 2K-3 2005	1
10	47039090000	SPARK PLUG CAP NGK REINFORC.04	1
12	50231012000	SEALING CUP FOR SPARK PLUG	1
13	51539093000	SPARK PLUG BR9ECMVX	1
16	59039006000	IGNITIONCOIL "IG5128"	1
31	50339031800	CDI UNIT 125 EXC 07	1
32	54839032200	WIRING HARNESS FOR CDI 2-ST.07	1
34	80011034000	VOLTAGE REGULATOR 04	1
35	50311035000	CONDENSATOR 2200MF ADP-48 2000	1
38	0023060123	COLLAR SCREW M6X12 TX	2
40	0025050166	HH COLLAR SCREW M5X16 TX30	3
42	0025060126	HH COLLAR SCREW M6X12 TX30	1
43	0025060166	HH COLLAR SCREW M6X16 TX30	1
44	0025060206	HH COLLAR SCREW M6X20 TX30	1

095033911 / C125033911

* NEW PART

X AS REQUIRED



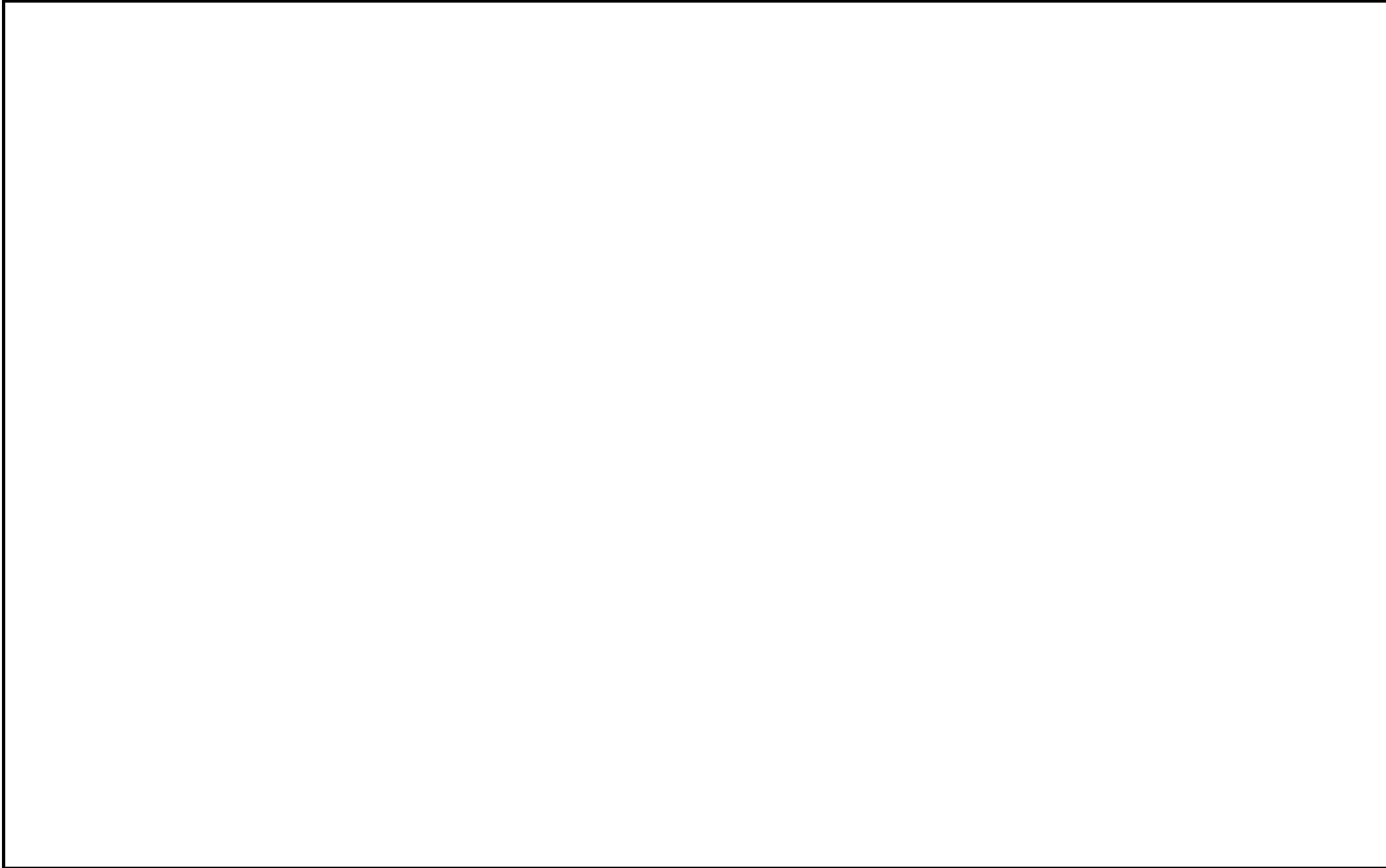



HUSABERG – a company of the KTM Group
A-5230 Mattighofen
www.husaberg.cc

KTM Group Partner



3CM081570LEN



Art.Nr.: 3CM081570LEN 5/2011