

" 08

BEDIENUNGSANLEITUNG

OWNERS MANUAL

Edition 2008

MANUEL D'UTILISATION



HUSABERG
4 STROKE FORCE

TABLE OF CONTENTS

	Page		Page
INTRODUCTION	2	Replacing fork springs	30
Important limited warranty and limited guarantee information	4	Changing the fork offset (caster)	31
SERIAL NUMBER LOCATIONS	5	How to change the handlebar position	33
Chassis number	5	Changing the spring preloading of the shock absorber	33
Engine-Number	5	Check chain tension	34
OPERATION INSTRUMENTS	6	Correct chain tension	34
Clutch lever	6	Chain maintenance	35
Hand decompression lever	6	Chain wear	35
Hand brake lever	6	General information about Husaberg disc brakes	36
Short circuit button	6	Changing the basic position the hand brake lever (FE)	37
Combination switch	7	Changing the basic position the hand brake lever (FS)	37
Flasher switch	7	Checking the brake fluid level - front brake	37
Headlamp switch (USA)	7	Refilling the front brake fluid reservoir	37
Indicator lamps	7	Checking the front brake pads	38
Starter button	8	Replacing the front brake pads (FE)	38
Emergency OFF switch (Australia)	8	Replacing the front brake pads (FS)	38
Electronic speedometer	8	Changing the basic position of the foot brake pedal	39
Kilometers or miles	13	Check the rear brake fluid level	39
Setting the clock	13	Refilling the rear brake fluid reservoir	39
Filler cap	14	Checking the rear brake pads	40
Fuel Taps	14	Replacing the rear brake pads	40
Choke	14	Dismounting and mounting the front wheel	41
Hot start device	14	Dismounting and mounting the rear wheel	42
Shift lever	15	Checking the shock absorption rubbers in the rear hub	43
Kickstarter	15	Checking spoke tension	43
Foot brake pedal	15	Tires, air pressure	44
Side stand	15	Check/set distance of the magnetic sensor	44
Plug in stand	16	Battery	45
Compression damping of fork	16	Charging the battery	45
Rebound damping of fork	16	Fuse	46
Changing the spring preload on the telescopic fork	16	Replacing headlight lamp/parking light lamp	46
Damping action during compression of shock absorber	17	Cooling system	47
Rebound damping of shock absorber	18	Checking the coolant level	47
Steering lock	18	Bleeding the cooling system	48
Instructions for initial operation	19	Replacing the glassfiber yarn packing of the silencer	48
Running in the Husaberg models	19	Cleaning the spark arrester	48
TIPS AND WARNINGS FOR STARTING THE MOTORCYCLE	19	Cleaning the air filter	49
DRIVING INSTRUCTIONS	20	Checking the adjustment of the hand decompression release cable	49
Check the following before each start	20	Adjusting the throttle cables	49
Starting when the engine is cold	21	Changing the original position of the clutch lever	50
Starting when the engine is warm	21	Checking the oil level of the hydraulic clutch	50
What to do when the engine is "flooded"	21	Bleeding of the hydraulic clutch	50
Starting off	22	Carburetor – Adjust idling	51
Shifting/Riding	22	Basic information on carburetor wear	51
Braking	22	Adjusting the mixture control screw	51
Stopping and parking	23	Checking the float level (float height)	52
Fuel	23	Draining the float chamber of the carburetor	52
PERIODIC MAINTENANCE SCHEDULE	24	Oil Circuit	52
MAINTENANCE WORK ON CHASSIS AND ENGINE	27	Checking the engine oil level	53
Checking and adjusting the steering head bearing	27	Engine oil	53
Breather plug front fork	28	Changing the engine oil	53
Cleaning the dust sleeves of the telescopic fork	28	Cleaning the oil screen	53
Basic suspension setup for the weight of the driver	29	Changing the oil filter	54
Checking the shock absorber and spring	29	TROUBLESHOOTING	55
Determining the static sag of the shock absorber	29	CLEANING, CONSERVATION, STORAGE	57
Determining the riding sag of the shock absorber	29	TECHNICAL DATA - ENGINE	58
Checking the basic setup of the telescopic fork	30	TECHNICAL DATA - CHASSIS	61
		HEAD WORD INDEX	63
		WIRING DIAGRAM	Appendix

INTRODUCTION

IMPORTANT

WE STRONGLY SUGGEST THAT YOU READ THIS MANUAL CAREFULLY AND COMPLETELY BEFORE GOING ON YOUR FIRST RIDE. IT CONTAINS A GREAT DEAL OF INFORMATION AND ADVICE WHICH WILL HELP YOU USE AND HANDLE YOUR BIKE PROPERLY.

IN YOUR OWN INTEREST, PLEASE PAY PARTICULAR ATTENTION TO NOTICES THAT ARE MARKED AS FOLLOWS:



WARNING: IGNORING THESE INSTRUCTIONS, CAN ENDANGER YOUR BODY AND YOUR LIFE.



CAUTION: IGNORING THESE INSTRUCTIONS COULD CAUSE DAMAGE TO PARTS OF YOUR MOTORCYCLE OR THAT THE MOTOR-CYCLE IS NOT ROAD-SAFE ANYMORE.



NOTE: USEFUL INFORMATION ON HANDLING AND SERVICING YOUR MOTORCYCLE.

Please insert the serial numbers of your motorcycle in the boxes below

Frame number:

Motor number:

Stamp of dealer:

CONSUMER INFORMATION FOR AUSTRALIA ONLY

The exhaust system on this vehicle has no owner serviceable parts. Should there be an increase in noise or damage to any component relating to the noise reduction system, replacement parts should be fitted by an Authorised dealer.

Tampering with noise control system prohibited

Owners are warned that the law may prohibit:

- (a) The removal or rendering inoperative by any person other than for purposes of maintenance, repair or replacement, of any device or element of design incorporated into any new vehicle for the purpose of noise control prior to its sale or delivery to the ultimate purchaser or while it is in use; and
- (b) the use of the vehicle after such device or element of design has been removed or rendered inoperative by any person.

HUSABERG RESERVES THE RIGHT TO MODIFY ANY EQUIPMENT, TECHNICAL SPECIFICATIONS, COLORS, MATERIALS, SERVICES OFFERED AND RENDERED, AND THE LIKE SO AS TO ADAPT THEM TO LOCAL CONDITIONS WITHOUT PREVIOUS ANNOUNCEMENT AND WITHOUT GIVING REASONS, OR TO CANCEL ANY OF THE ABOVE ITEMS WITHOUT SUBSTITUTING THEM WITH OTHERS. IT SHALL BE ACCEPTABLE TO STOP MANUFACTURING A CERTAIN MODEL WITHOUT PREVIOUS ANNOUNCEMENT.

INTRODUCTION

We would like to congratulate you on your purchase of a Husaberg motorcycle.

You are now the owner of a state-of-the-art sport motorcycle that guarantees to bring you lots of fun and enjoyment, provided that you clean and maintain it appropriately. **Before you go for your first ride, be sure to read this manual carefully and thoroughly in order to familiarize yourself with how to operate your new motorcycle and with its characteristics, even if this means that you will have to dedicate some of your valuable time to this task. Only by doing so will you learn how to tune your motorcycle to your specific needs and how to protect yourself against injury. Besides, this manual contains important information on motorcycle maintenance.** At the time this manual was typeset, it was up-to-date with the latest state of this production series. Please note that motorcycle features may vary according to the effective legal provisions. It cannot be completely ruled out, however, that minor discrepancies may exist resulting from further design upgrades of these motorcycles. This manual is an important part of your motorcycle and should be passed on to any subsequent owner in case you decide to sell it.

The work marked with an * in the chapter "Servicing the chassis and engine" must be performed by an authorized Husaberg dealer. If such service work becomes necessary during a competition, it must be performed by a trained mechanic.

For your own safety, use Husaberg-approved parts and accessories only. Husaberg is not liable for damage that arises in connection with the use of other products.

Take special care to follow the recommended run in, inspection, and maintenance intervals. Heeding these guidelines will significantly increase the life of your motorcycle. Be sure to have your motorcycle serviced by an authorized Husaberg dealer to maintain the validity of your warranty.

Off-road / Supermoto motorcycle driving is a wonderful sport and we hope that you will be able to enjoy it to the full. It may, however, involve potential problems for the environment or lead to conflicts with others. These problems or conflicts can be avoided if the motorcycle is used responsibly. To safeguard the future of motorcycle sports, make sure that you use the motorcycle in accordance with the law, show that you are environmentally conscious and respect the rights of others.

We wish you a lot of fun when driving !

HUSABERG
5230 MATTIGHOFEN, AUSTRIA

ALL RIGHTS RESERVED TO MAKE ALTERATIONS TO DESIGN AND MODEL.

© by HUSABERG

INTRODUCTION

IMPORTANT LIMITED WARRANTY AND LIMITED GUARANTEE INFORMATION

Husaberg sports motorcycles are designed and constructed to resist the usual wear and tear of normal use in competitions.

The motorcycles comply with the regulations and categories currently in effect with the leading international motorcycle associations.

Observance of the service, maintenance and tuning instructions for the engine and chassis specified in the Owner's Manual is a prerequisite for faultless operation and the avoidance of premature wear. An improperly tuned chassis can lead to damage and breakage of the chassis components (see chapter on checking the basic chassis setting).

The service work described in the "Lubrication and maintenance chart" must be carried out and confirmed by an authorized Husaberg dealer, otherwise your warranty will become void.

The fuels and lubricants specified in the Owner's Manual or fluids with equivalent specifications must be used in accordance with the maintenance schedule.

No claims can be filed under the warranty for damage or consequential damage caused by manipulations or conversions to the motorcycle.

The use of the motorcycle under extreme conditions, e.g. on extremely muddy and wet terrain, can lead to higher than average wear on components such as the drive train or the brakes. In this case it may become necessary to service or replace wear parts before the service limit specified in the maintenance schedule has been reached.

MODELS FE

"On the road" approved models are only allowed on public roads in the original homologated (throttled) version. **Without this performance restriction (i.e. de-throttled), these models are only allowed to be driven off-road and not on public roads.** The FE models are designed for off-road sports endurance competitions (enduro) and not suitable for predominant motocross use.

MODELS FS

The FS models are only allowed on public roads in the original homologated (throttled) version. **Without this performance restriction (i.e. de-throttled), these models are only allowed to be driven in Supermoto competitions but not on public roads.**

No warranty will be assumed if the bike is used in races or competitions.



REG.NO. 12 100 6061

In accordance with the international quality management ISO 9001 standard, Husaberg uses quality assurance processes that lead to the highest possible product quality.

SERIAL NUMBER LOCATIONS

CHASSIS NUMBER

The chassis number is stamped on the right side of the steering head tube. Enter this number in the field on page no 2.

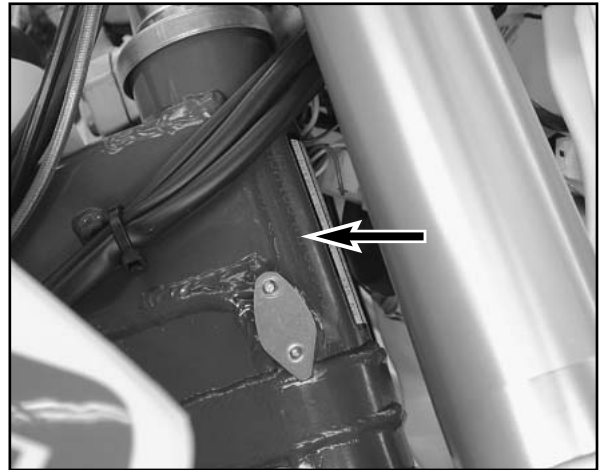

ENGINE-NUMBER

The engine number is embossed in the engine case on the left side of the engine under the radiator hose.



ENGLISH

OPERATION INSTRUMENTS

CLUTCH LEVER

The clutch lever (1) is located on the left side of the handlebar. The adjusting screw (A) is used to change the original position of the clutch lever (see maintenance work on chassis and engine).

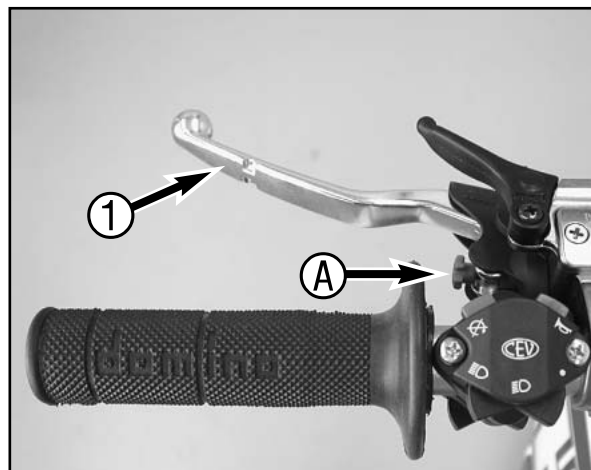

HAND DECOMPRESSION LEVER

The hand decompression lever (2) is needed only if the carburetor overflows after a fall. To "pump the engine free", pull the hand decompression lever during the starting procedure.

The outer end of the lever must provide for a backlash of approx. 10 mm (0.4 in) at all times. Only thereafter may it cause valve motion (to be recognized by the stronger resistance which the hand decompression lever encounters).

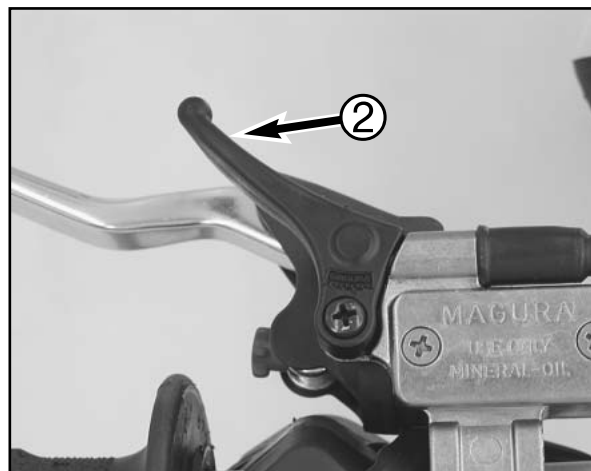

HAND BRAKE LEVER

The hand brake lever (3) is located on the right side of the handlebar and actuates the front brake. The basic setting of the hand brake lever can be adjusted (see maintenance work).

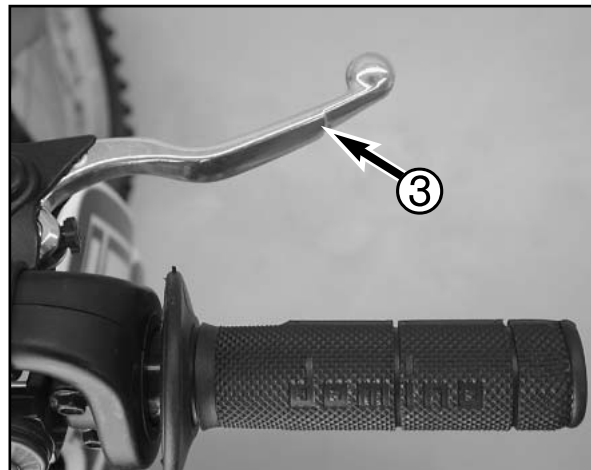

SHORT CIRCUIT BUTTON

The short circuit button (4) turns off the engine. When pressing this button, the ignition circuit is short-circuited.

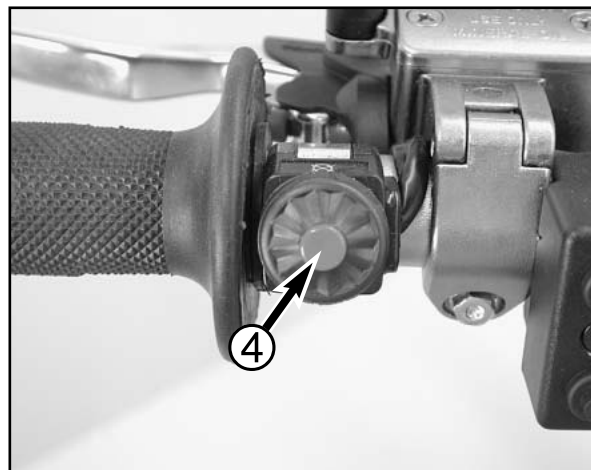

OPERATION INSTRUMENTS

COMBINATION SWITCH

The light switch has 2, respectively 3 switch positions.

(A) = Light off (this function is not available in all models)

(B) = Low beam on

(C) = High beam on

You may use button (1) to actuate the horn.

The red short circuit button (2) serves to switch off the engine. Leave the switch pressed until the engine stops.

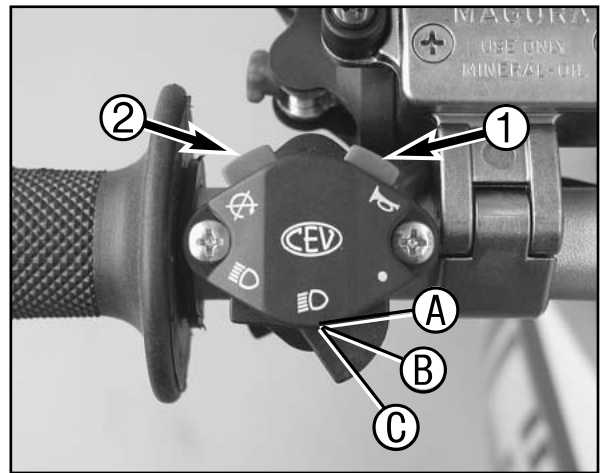

FLASHER SWITCH

The flasher switch (3) is a separate unit and is mounted on the left portion of the handlebar.

The wire harness is designed in a way that whenever you want to use your bike off-road, you can dismount the entire turn indicator system without affecting the function of the remaining electrical system.

← Flasher left

→ Flasher right

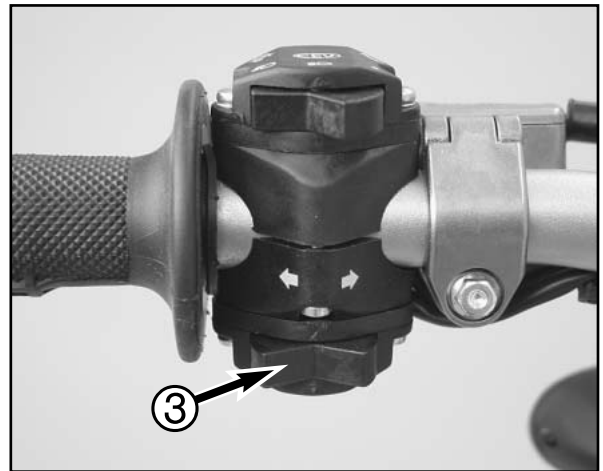

HEADLAMP SWITCH (USA)

In this model the headlamp is switched on with the pull switch (4).

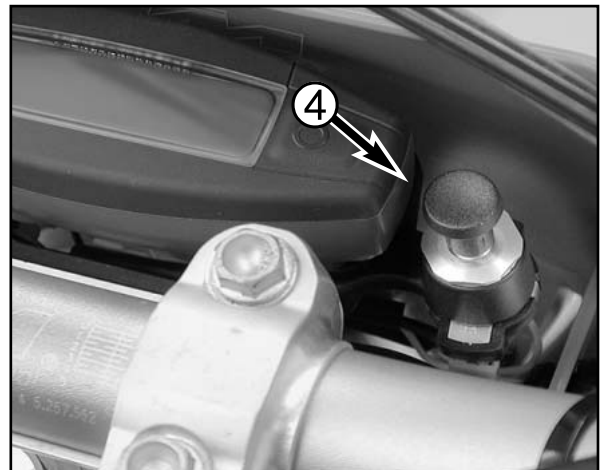

INDICATOR LAMPS

↔ The green control lamp (5) flashes in the same rhythm as the flashing indicator when the indicator is working.

⦿ The blue control lamp (6) lights up when the high beam is on.

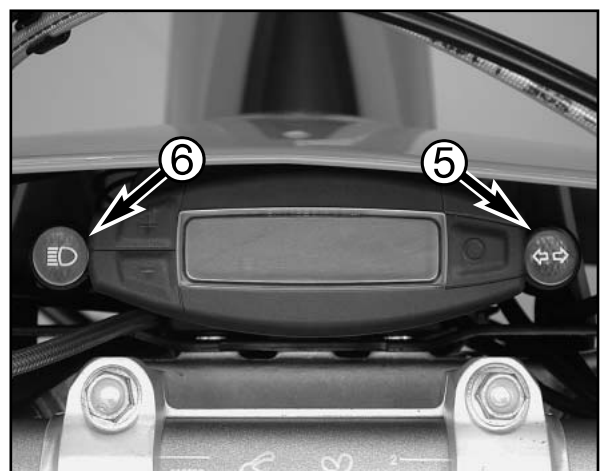

OPERATION INSTRUMENTS



STARTER BUTTON

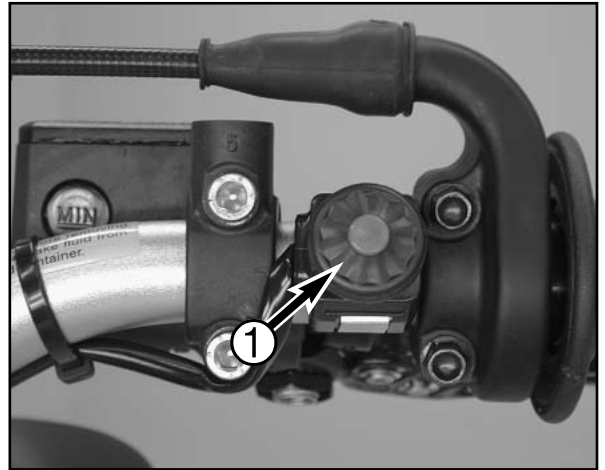

 Pushing the black starter button (1) will actuate the E-starter



EMERGENCY OFF SWITCH (AUSTRALIA)

The red emergency-OFF switch (2) is arranged adjacent to the throttle grip.

  In this position, the E-starter is operational and the engine can be started.

  In this position, the E-starter and ignition circuits are interrupted. The E-starter cannot be actuated, and the engine will not start, not even if you attempt to start it with the kickstarter.

 Pushing the black starter button (3) will actuate the E-starter.

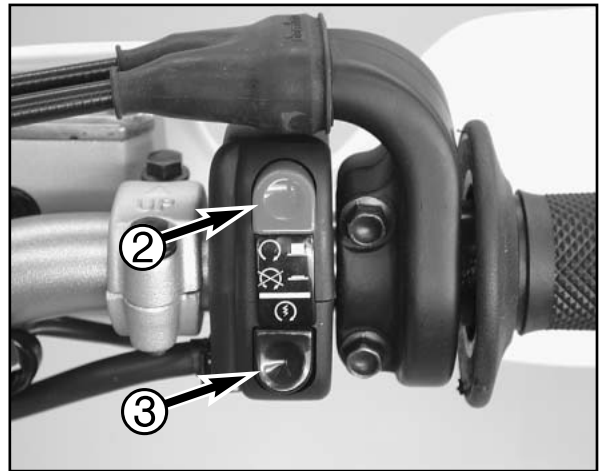

ELECTRONIC SPEEDOMETER

The display in the electronic speedometer is activated as soon as you press a button on the speedometer or an impulse is received from the wheel sensor. The display lights up when the engine is running.

The display is cleared if no button is pressed for 1 minute or no impulse is received from the wheel sensor.

The  button is used to change between display modes.

The + and - buttons are used to control various functions.

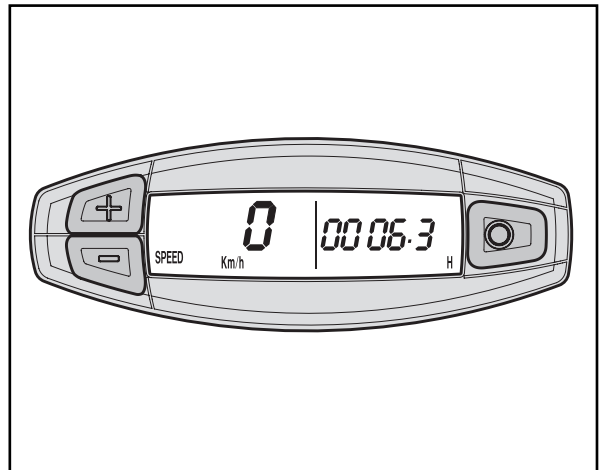

OPERATION INSTRUMENTS

TEST

All of the display segments briefly light up for the display function test.

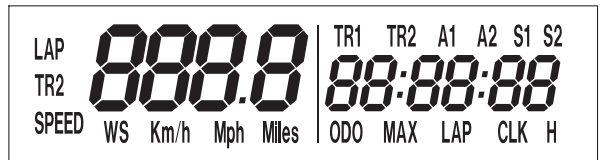

WS (WHEEL SIZE)

The display changes and the circumference of the front wheel is briefly displayed in millimeters (2205 mm corresponds to a front wheel circumference of 21" with production tires).

Afterwards the display will return to the previous display mode.



SPEED DISPLAY MODE / H (SERVICE HOURS)

Only the SPEED / H and SPEED / ODO display modes are activated in the condition at delivery. SPEED/H is displayed whenever the display is activated and the front wheel is not turning. It automatically changes to the SPEED/ODO display mode as soon as the front wheel starts turning.

SPEED displays the speed.

H displays the engine's service hours. The service hour counter starts to count as soon as you start the engine. The displayed figure cannot be changed.

Service intervals are indicated in service hours for some Husaberg offroad motorcycles, making the service hour counter a very practical function.



SPEED / ODO DISPLAY MODE (ODOMETER)

The SPEED/ODO mode displays the speed and the total distance traveled. The display automatically changes to the SPEED/H display mode when the front wheel stops turning.

- | | |
|-------------------------------|----------------------------------|
| + button | no function |
| - button | no function |
| briefly press ○ button | changes to the next display mode |
| hold ○ button 3 secs. | changes to the next display mode |

The electronic speedometer has a number of display modes (functions) that you can also activate (reveal) (see: Activating and deactivating display modes).



OPERATION INSTRUMENTS

ACTIVATING AND DEACTIVATING DISPLAY MODES

In the display mode SPEED/H, press and hold the **○** button for 3 seconds to access the SETUP menu. The active functions will be displayed. The blinking function can be activated by pressing the + button and deactivated by pressing the – button.

Press and hold the **○** button 3 seconds to store the settings.

If no button is pressed for 20 seconds, the setting will be stored automatically and the display will return to the SPEED/H mode.

+ button	activates the blinking display
– button	deactivates the blinking display
briefly press ○ button	changes to the next display without changing any settings
hold ○ button 3 secs.	starts the SETUP stores the settings and changes to the SPEED/H mode



The following display modes can be activated:

TR1	tripmaster 1
TR2	tripmaster 2
A1	average speed 1
A2	average speed 2
S1	stop watch 1
S2	stop watch 2
CLK	clock
LAP	lap time
MAX	maximum speed
KMH/MPH	display in kilometers or miles (see: Kilometers or miles)

If you have activated all of the display modes, they will be displayed in the following order:

SPEED/H, SPEED/CLK, SPEED/LAP, LAP/LAP, SPEED/MAX, SPEED/ODO, SPEED/TR1, SPEED/TR2, SPEED/A1, SPEED/A2, SPEED/S1, SPEED/S2

SPEED / CLK (TIME) DISPLAY MODE

CLK displays the time in hours, minutes and seconds.

+ button	no function
– button	no function
briefly press ○ button	changes to the next display mode
hold ○ button 3 secs.	set the clock menu

To set the clock, see „Setting the clock“.



SPEED / LAP (LAP TIME) DISPLAY MODE

You can use the manual stop watch to stop and store up to 10 lap times, which you can view in the LAP/LAP display mode (see below).

LAP displays the lap times in hours, minutes and seconds.

+ button	Starts and stops the stop watch, lap time is not reset to 0
– button	Stops the stop watch, stores the lap time and restarts the stop watch again. The time is reset to 0. A total of 10 lap times can be stored. If the lap time continues to run after you press the - button, all 10 memory locations are occupied. To clear all of the stored lap times, hold the ○ button for 3 seconds in the SPEED/LAP mode. Up to 10 lap times can be stored in this way.
briefly press ○ button	Changes to the next display mode. If no lap time is stored or the motorcycle is driving, the LAP/LAP mode will be skipped.
hold ○ button 3 secs.	Clears all LAP figures

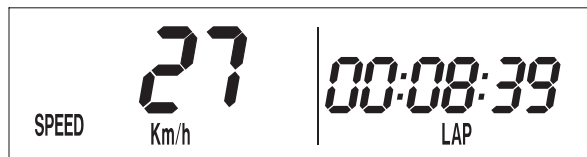

OPERATION INSTRUMENTS

LAP / LAP DISPLAY MODE (TO VIEW LAP TIMES)

The LAP/LAP display mode will only be shown if lap times have been stored and the front wheel has stopped. It will display the lap number and the stopped lap time in hours, minutes and seconds. Press the + button to access the next lap time.

To clear all of the stored lap times, hold the **○** button for 3 seconds in the SPEED/LAP mode.

+ button	changes to the next lap time
– button	no function
briefly press ○ button	changes to the next display mode
hold ○ button 3 secs.	changes to the next display mode



SPEED / MAX DISPLAY MODE (MAXIMUM SPEED)

MAX displays the maximum speed traveled and is always active.

+ button	no function
– button	no function
briefly press ○ button	changes to the next display mode
hold ○ button 3 secs.	clears the MAX figure



SPEED / TR1 DISPLAY MODE (TRIPMASTER 1)

The TR1 tripmaster is always active and counts to 999.9. It is used to measure the length of a trip or the distance between 2 refueling stops. TR1 is linked to A1 (average speed 1). The calculation of these figures is activated by the first impulse received from the wheel sensor (when the front wheel starts to turn) and stops 3 seconds after the last impulse is received (when the front wheel has stopped).

The TR1, A1 and S1 figures are automatically cleared after passing 999.9.

+ button	no function
– button	no function
briefly press ○ button	changes to the next display mode
hold ○ button 3 secs.	clears the TR1, S1, A1 figures

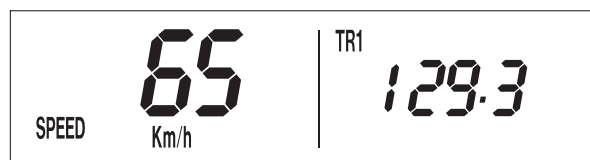

SPEED / TR2 DISPLAY MODE (TRIPMASTER 2)

The tripmaster 2 is always active and counts to 999.9. Contrary to TR1, the displayed figure can be changed using the + and – buttons. This is a very useful function for trips taken according to a roadbook.

+ button	increases the TR2 figure
– button	decreases the TR2 figure
briefly press ○ button	changes to the next display mode
hold ○ button 3 secs.	clears the TR2 figure



OPERATION INSTRUMENTS

SPEED / A1 DISPLAY MODE (AVERAGE SPEED 1)

A1 shows the average speed based on the TR1 (tripmaster 1) and S1 (stop watch 1) figures. The calculation of this figure is activated by the first impulse received from the wheel sensor and stops 3 seconds after the last impulse is received.



- | | |
|-------------------------------|----------------------------------|
| + button | no function |
| - button | no function |
| briefly press ○ button | changes to the next display mode |
| hold ○ button 3 secs. | clears the TR1, S1, A1 figures |

SPEED / A2 DISPLAY MODE (AVERAGE SPEED 2)

A2 shows the average speed based on the TR2 (tripmaster 2) and S2 (stop watch 2) figures.

The displayed figure can deviate from the actual average speed if the TR2 figure was changed manually or if S2 was not stopped after the trip.

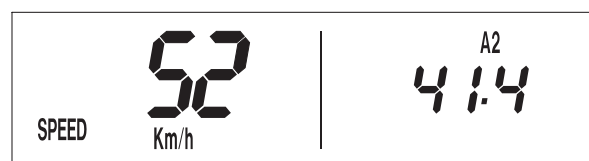

- | | |
|-------------------------------|----------------------------------|
| + button | no function |
| - button | no function |
| briefly press ○ button | changes to the next display mode |
| hold ○ button 3 secs. | changes to the next display mode |

SPEED / S1 DISPLAY MODE (STOP WATCH 1)

S1 shows the traveling time based on TR1 and continues to run whenever it receives impulses from the wheel sensor. The calculation of this figure is activated by the first impulse received from the wheel sensor and stops 3 seconds after the last impulse is received.

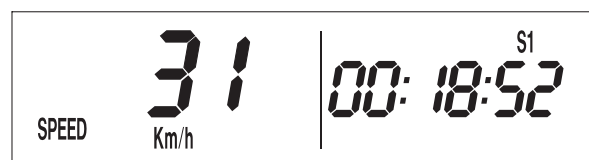

- | | |
|-------------------------------|----------------------------------|
| + button | no function |
| - button | no function |
| briefly press ○ button | changes to the next display mode |
| hold ○ button 3 secs. | clears the TR1, S1, A1 figures |

SPEED / S2 DISPLAY MODE (STOP WATCH 2)

S2 is a manual stop watch. Start the stop watch by pressing the + button, press again to hold. Press again to continue timing.

Press the **○** button to change to the next mode. The S2 display will blink in the other modes if S2 continues to run in the background. To stop S2, return to the SPEED/S2 mode and press the + button.



- | | |
|-------------------------------|----------------------------------|
| + button | starts and stops the stop watch |
| - button | no function |
| briefly press ○ button | changes to the next display mode |
| hold ○ button 3 secs. | clears the S2 figure |

OPERATION INSTRUMENTS

KILOMETERS OR MILES

The unit (kilometers or miles) can also be changed. The ODO figure will be retained and converted accordingly. The TR1, A1, S1, TR2 and A2 figures will be cleared.

To select the unit, select the SPEED/H mode and hold the **○** button for 3 seconds to access the SETUP menu. Press the **○** button until the KMH/MPH function blinks. Press the + button briefly to move to the options. Press the + button for KMH or the – button for MPH.

To set, briefly press the **○** button 1 x and hold for 3 seconds until the display returns to the SPEED/H mode.

If no button is pressed for 20 seconds, the setting will be stored automatically and the display will return to the SPEED/H mode.

- + button to access the menu
- button to activate the KMH display
- briefly press **○** button to activate the MPH display
- hold **○** button 3 secs. changes to the next mode
- hold **○** button 3 secs. changes from the menu to the SETUP menu
- hold **○** button 3 secs. stores and closes the SETUP menu

SETTING THE CLOCK

To set the clock, switch the ignition off and select the SPEED/CLK mode. Press and hold the **○** button for 3 seconds. The blinking digits can be changed using the + and - buttons. Press the **○** button to move to the next digit. 0-12 will show the time in the 12-hour mode, 0-24 in the 24-hour mode.

Press and hold the **○** button for 3 seconds to store the settings.

If no button is pressed for 20 seconds, the settings will be stored automatically and the display will return to the SPEED/CLK mode.

- + button time +
- button time -
- briefly press **○** button changes to the next digit
- hold **○** button 3 secs. starts the SETUP menu
- hold **○** button 3 secs. stores the time and changes to the SPEED/CLK display mode

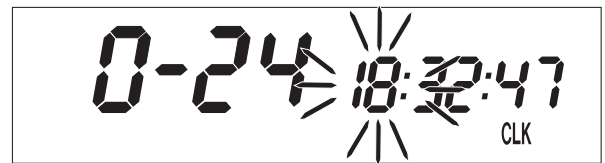
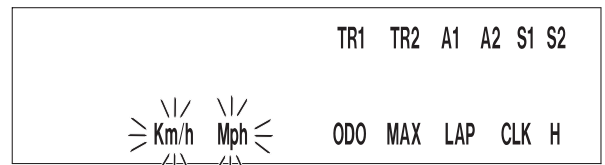

ENGLISH

OVERVIEW OF THE ELECTRONIC SPEEDOMETER FUNCTIONS

Motorcycle is standing	Motorcycle is driving					
		display	briefly press + button	briefly press – button	briefly press ○ button	hold ○ button 3 secs.
X		SPEED / H	no function	no function	next display mode	displays the SETUP menu
X	X	SPEED / CLK	no function	no function	next display mode	Setting the clock menu
X	X	SPEED / LAP	starts/stops LAP without clearing LAP figure	stops LAP, stores LAP figure, resets LAP to 0	next display mode	clears all LAP figures
X		LAP / LAP	next figure	no function	next display mode	next display mode
X	X	SPEED / MAX	no function	no function	next display mode	clears MAX
	X	SPEED / ODO	no function	no function	next display mode	next display mode
X	X	SPEED / TR1	no function	no function	next display mode	clears TR1, S1, A1
X	X	SPEED / TR2	increases the TR2 figure	reduces the TR2 figure	next display mode	clears TR2
X	X	SPEED / A1	no function	no function	next display mode	clears TR1, S1, A1
X	X	SPEED / A2	no function	no function	next display mode	next display mode
X	X	SPEED / S1	no function	no function	next display mode	clears TR1, S1, A1
X	X	SPEED / S2	starts - stops S2	no function	next display mode	clears S2

If the CLK, LAP, MAX, TR1, TR2, A1, A2, S1 and S2 figures are suddenly cleared, the battery in the electronic speedometer is empty and must be replaced (see: Replacing the battery in the electronic speedometer).

A tripmaster switch is available as an accessory that lets you control the electronic speedometer functions from the handlebar.

OPERATION INSTRUMENTS

FILLER CAP

To open the filler cap: Turn the filler cap counter-clockwise.

To close the filler cap: Put the filler cap on and tighten it by turning it clockwise.

Install the tank breather hose (1) without kinks.

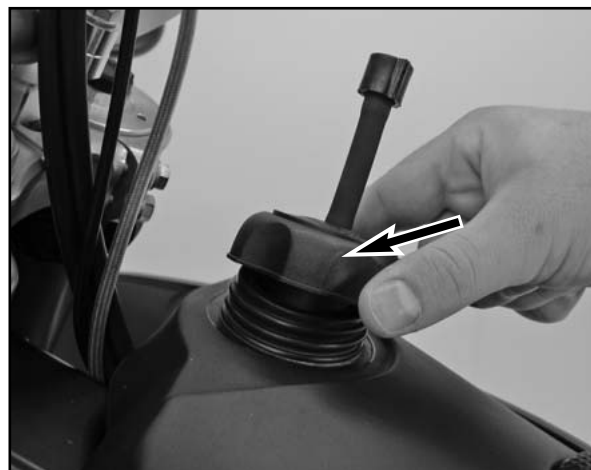

FUEL TAPS

OFF The fuel tap is closed in this position. No fuel can flow to the carburetor.

ON Turn the twist grip in the ON position to operate the motorcycle. Now fuel can flow to the carburetor. The tank will drain completely in this position.

A threaded fuel tap (1) is also located on the left side. No fuel can flow to the carburetor if it is screwed-in. Fuel will flow to the carburetor if the fuel tap is screwed-out.

 **NOTE: No RES function is available.**

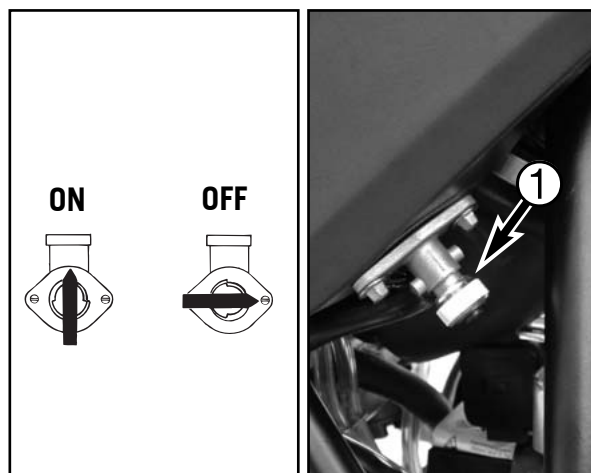

CHOKE

If you pull the choke button (2) out as far as possible, a bore in the carburetor will be opened through which the engine may take in additional fuel. The result is a „fat“ fuel-air mixture of the type needed for cold starts. To deactivate the choke, push the choke button back into its basic position.

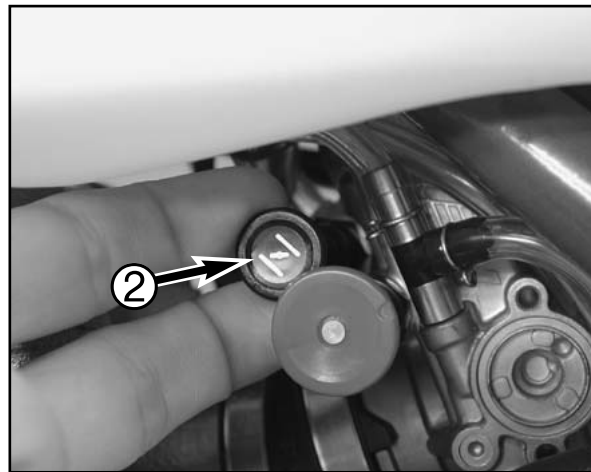

HOT START DEVICE

If you pull the hot start device (3) out as far as possible, a bore in the carburetor will be opened through which the engine may take in additional air. The result is a „lean“ fuel-air mixture of the type needed for hot starts.

To deactivate the hot start device, push the hot start button back into its basic position.

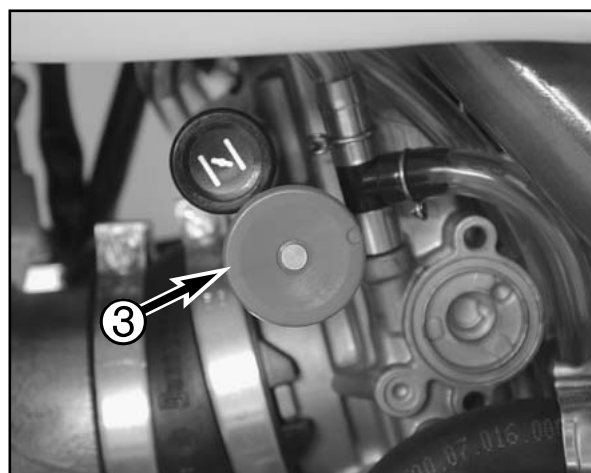

OPERATION INSTRUMENTS

SHIFT LEVER

The shift lever is mounted on the left side of the engine. The position of the gears is shown in the illustration. Neutral, or the idle speed, is located between first and second gear.

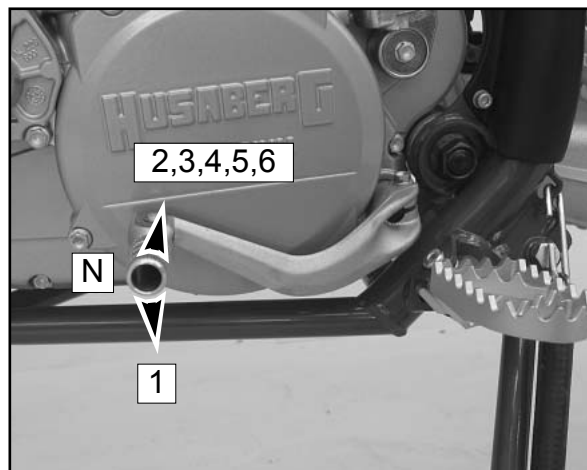

KICKSTARTER

The kickstarter is located on the left side of the engine. The upper part is tiltable.



FOOT BRAKE PEDAL

The foot brake pedal is located in front of the right footrest. Its basic position can be adjusted to your seat position (see maintenance work).

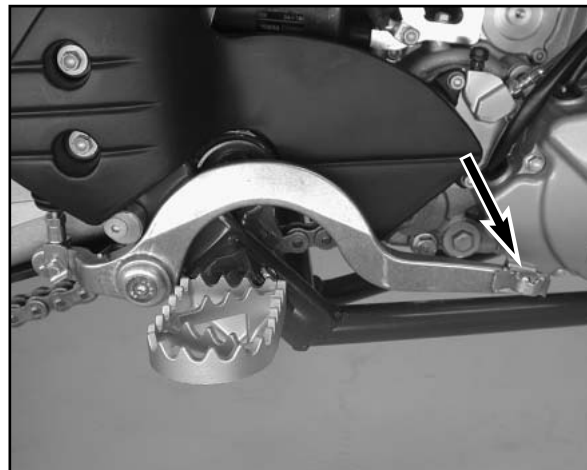

SIDE STAND

Push the side stand to the ground with your foot and load it with the motorcycle. Make sure that you put your bike on solid ground and in a secure position.



WARNING: The side stand swings up rapidly when the load is released. Make sure you are not standing in the way.



OPERATION INSTRUMENTS

PLUG IN STAND

The plug-in stand can be attached to the wheel spindle on the left side of the motorcycle.



COMPRESSION DAMPING OF FORK

Hydraulic compression damping determines the reaction when the fork is compressed. The degree of compression can be adjusted with adjusting screws at the bottom of the fork legs. Remove the protecting cap (1). Turn the adjusting screws (2) clockwise to increase damping, turn it counterclockwise to reduce damping during compression.

STANDARD ADJUSTMENT

- turn adjusting screw clockwise as far as it will go
- turn it back by as many clicks as are specified for the relevant type of fork

Typ WP Suspension 14457D0219 clicks

Typ WP Suspension 14457D0320 clicks

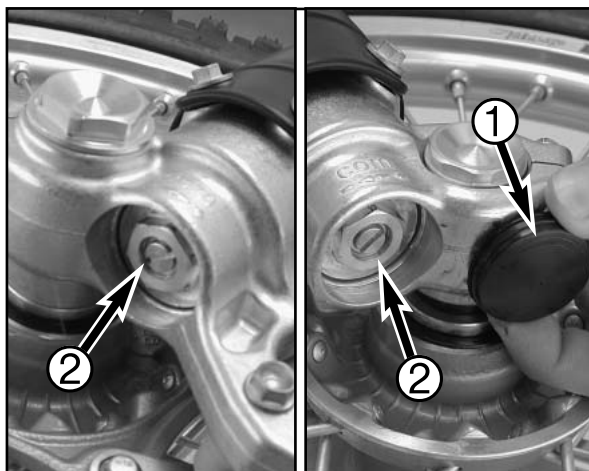

REBOUND DAMPING OF FORK

Hydraulic rebound damping determines the reaction when the fork is rebound. By turning the adjusting screw (3) (REB), the degree of damping of the rebound can be adjusted. Turn the knob clockwise to increase damping, turn it counterclockwise to reduce damping during rebounding.

STANDARD ADJUSTMENT

- turn adjusting screw clockwise as far as it will go
- turn it back by as many clicks as are specified for the relevant type of fork

Typ WP Suspension 14457D0220 clicks

Typ WP Suspension 14457D0315 clicks

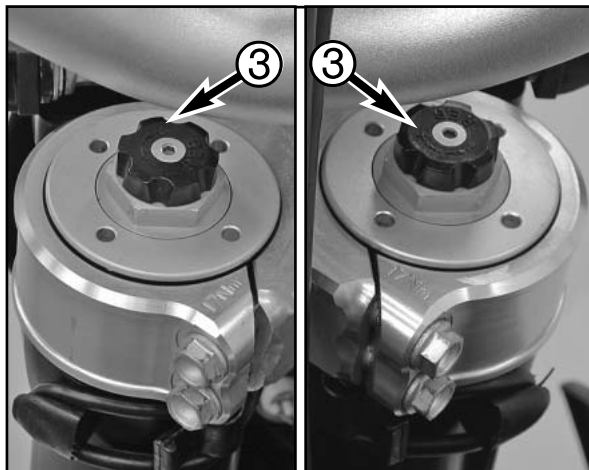

CHANGING THE SPRING PRELOAD ON THE TELESCOPIC FORK

The telescopic forks of these models come with a preload adjuster for easy adjustment of the spring preload. You can adjust the spring preload ± 9 mm by turning the adjusting screws (basic position = middle position). Turning in a clockwise direction will increase the prestress, turning in a counterclockwise direction will decrease the prestress.

Changing the spring preload will not affect the rebound damping adjustment.

Generally, if the spring preload is higher, the rebound damping should also be set higher.

NOTE:

Always turn the adjusting screws the same distance on both fork legs. Different spring preloads on the fork legs will reduce the telescopic fork's response.



OPERATION INSTRUMENTS

DAMPING ACTION DURING COMPRESSION OF SHOCK ABSORBER

The shock absorber can synchronize the compression damping in the low and high-speed range separately (Dual Compression Control).

Low and high speed refers to the movement of the shock absorber during compression and not to the speed of the motorcycle.

The low and high-speed technology overlaps.

The low-speed setting is primarily for slow to normal shock absorber compression rates.

The high-speed setting is effective at fast compression rates.

Turning in a clockwise direction will increase the damping, turning counterclockwise will decrease the damping.



STANDARD LOW-SPEED SETTING:

- turn the adjusting screw (1) to the limit in a clockwise direction using a screwdriver .
- unscrew the respective number of clicks for the specific type of shock absorber in a counterclockwise direction.

Typ WP Suspension 12457D0218 clicks

Typ WP Suspension 12457D0312 clicks

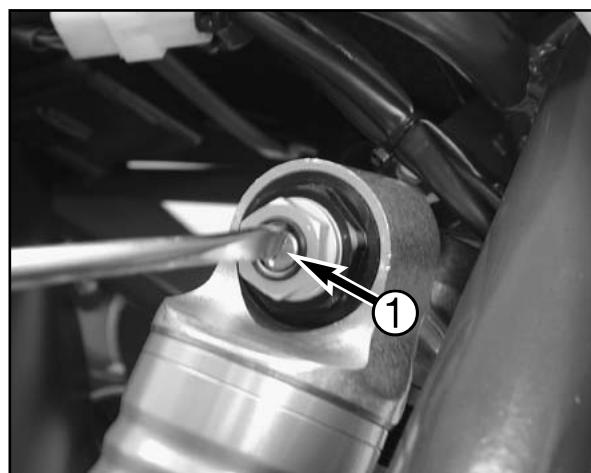

STANDARD HIGH-SPEED SETTING:

- turn the adjusting screw (2) to the limit in a clockwise direction using a box wrench.
- unscrew the respective number of turns for the specific type of shock absorber in a counterclockwise direction.

Typ WP Suspension 12457D022 turns

Typ WP Suspension 12457D032 turns

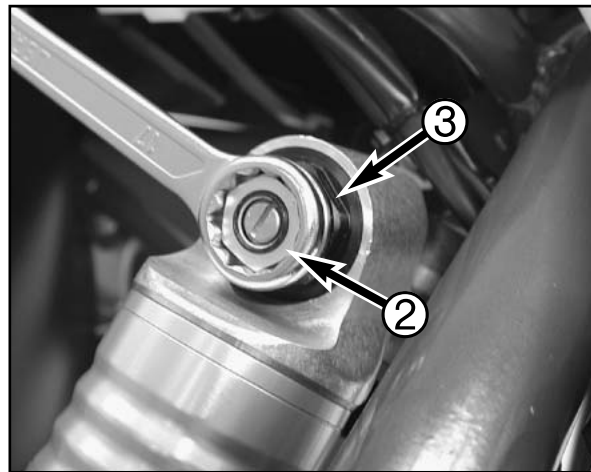

WARNING: The damping unit of the shock absorber is filled with high-compression nitrogen. Never try to take the shock absorber apart or to do any maintenance work yourself. Severe injuries could be the result. Never unscrew the black screw connection (3) (24mm).

OPERATION INSTRUMENTS

REBOUND DAMPING OF SHOCK ABSORBER

By using the adjusting screw (1), the degree of damping of the rebound can be adjusted. Turn the knob clockwise to increase damping, turn it counterclockwise to reduce damping during rebounding.

STANDARD ADJUSTMENT:

- turn the adjusting screw clockwise to the stop.
- then turn the adjusting screw counterclockwise, counting the number of clicks that corresponds to the respective type of shock absorber.

Typ WP Suspension 12457D0220 clicks

Typ WP Suspension 12457D0310 clicks

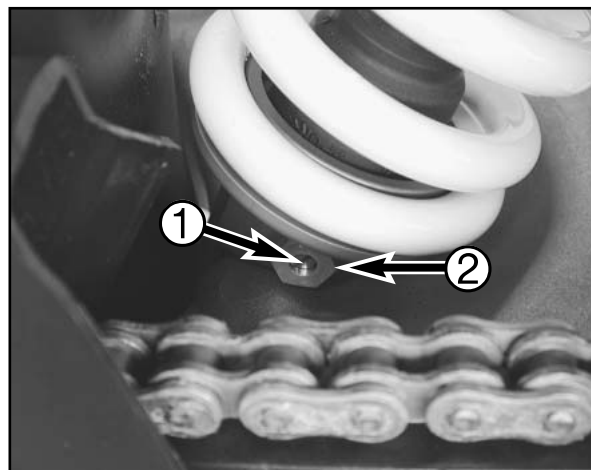

WARNING: The damping unit of the shock absorber is filled with high-compression nitrogen. Never try to take the shock absorber apart or to do any maintenance work yourself. Severe injuries could be the result. Never unscrew the black screw connection (2) (15mm).

STEERING LOCK

The lock mounted on the steering head locks the steering system. To lock, turn the handlebar all the way to the left, insert the key, turn to the left, press in, turn to the right and pull off the key.



CAUTION: Never leave the key inserted in the steering lock. If you turn the handlebar to the right the key could get damaged.

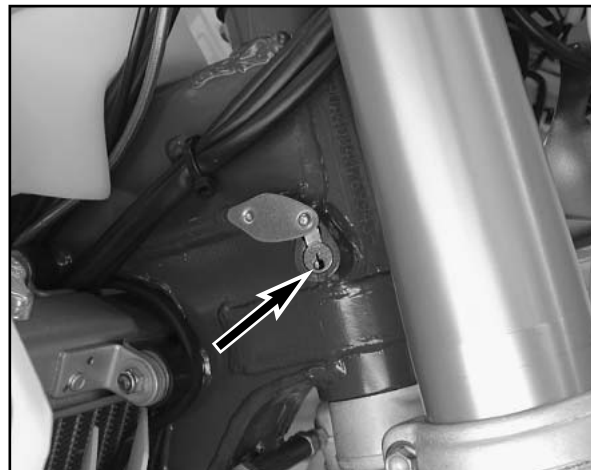

TIPS AND WARNINGS FOR STARTING THE MOTORCYCLE

INSTRUCTIONS FOR INITIAL OPERATION

- Verify that your Husaberg dealer performed the PREPARATION OF VEHICLE jobs (see Customer Service Manual).
- Read these operating instructions carefully before your first ride.
- Familiarize yourself with the operating elements.
- Set the clutch lever, the handbrake lever, and the footbrake pedal to the positions that are most convenient for you.
- Get used to handling the motorcycle on an empty parking lot or open space, before starting on a longer drive. Also try to drive as slowly as possible and in a standing position, to improve your feeling for the vehicle.
- Do not drive along off-road tracks which go beyond your ability and experience.
- Hold the handlebars with both hands and leave your feet on the foot rests while driving.
- Remove your foot from the foot brake lever when you are not braking. If the foot brake lever is not released the brake pads rub continuously and the braking system is over-heated.
- Do not make any alterations to the motorcycle and always use ORIGINAL Husaberg SPARE PARTS. Spare parts from other manufacturers can impair the safety of the motorcycle.
- Motorcycles are sensitive to alterations in the distribution of weight. If you are taking luggage with you, this should be secured as close as possible to the middle of the vehicle; distribute the weight evenly between the front and rear wheel. Never exceed the maximum permissible laden weight and the axle weights. The maximum permissible laden weight is comprised of the following components:
 - Motorcycle ready for operation and tank full
 - Luggage
 - Driver with protective clothing and helmet.
- Pay attention to the running-in procedure.

RUNNING IN THE HUSABERG MODELS

Even very precisely machined sections of engine components have rougher surfaces than components which have been sliding across one another for quite some time. Therefore, every engine needs to be broken in.

For this reason, do not load the engine more than 50% of its capacity during the first 3 operating hours. Besides, the engine speed must not exceed 7000 rpm. Avoid going full-throttle!

In the following 12 operating hours, you may load the engine up to 75% of its capacity. Use the motorcycle on various types of terrain (road, easy off-road trails).



CAUTION: The Husaberg models were uncompromisingly designed for off-road competition purposes only. "On the road" approved models FE/FS are only allowed on public roads in the original homologated (throttled) version. Avoid extended on-road rides at full throttle.



WARNING: Wear suitable clothing when driving a motorcycle. Clever Husaberg drivers always wear a helmet, boots, gloves and a jacket, regardless of whether driving all day or just for a short trip. The protective clothing should be brightly colored so that other vehicles can see you as early as possible.

Always turn on the light to make sure that other drivers become aware of you as early as possible.

Do not drive after having consumed alcohol.

Only use accessories recommended by Husaberg. For example, front panelling can impair the driving properties of the motorcycle. Cases, extra tanks, etc. can alter the weight distribution and thus also impair the vehicles driving properties.

The front and rear wheel may only be fitted with tires that have the same profile type.

The Husaberg models are designed and dimensioned for 1 person only. Never take another rider along.

Observe the traffic regulations, drive defensively and try to look ahead as far as possible so that any hazards can be recognized as early as possible.

Adjust your driving speed according to the conditions and your driving skills.

Drive carefully on unknown roads or on unfamiliar trials.

When driving off-road, always have a friend on a second motorcycle to keep you company, so that you can help each other should difficulties arise.

Replace the helmet visor or goggle lens when scratched or damaged. If bright light shines through a scratched visor or lens, the operator will be blinded.

Never leave your motorcycle without supervision if the engine is running.

When riding your motorcycle, please bear in mind that other people may feel molested by excessive noise.

DRIVING INSTRUCTIONS

CHECK THE FOLLOWING BEFORE EACH START

When you start off, the motorcycle must be in perfect technical condition. For safety reasons, you should make a habit of performing an overall check of your motorcycle before each start.

The following checks should be performed:

1 CHECK THE OIL LEVEL

Insufficient oil results in premature wear and consequently to engine damage. Too much engine oil will lead to higher oil consumption and will clog the carburetor.

2 FUEL

Check that there is sufficient fuel in the tank; when closing the filler cap, check that the tank venting hose is free of kinks.

3 CHAIN

A loose chain can fall from the chain wheels; an extremely worn chain can tear, and insufficient lubrication can result in unnecessary wear to the chain and chain wheels. Excessive tensioning of the chain will put additional load on the components of the secondary drivetrain (chain, bearings of transmission and rear wheel). Aside from resulting in premature wear, if worst comes to worst the chain may rupture or the countershaft of the transmission may break.

4 TIRES

Check for damaged tires. Tires showing cuts or dents must be replaced. The tread depth must comply with the legal regulations. Also check the air pressure. Insufficient tread and incorrect air pressure deteriorate the driving performance.

5 BRAKES

Check correct functioning of the braking system. Check for sufficient brake fluid in the reservoir. The reservoirs have been designed in such a way that brake fluid does not need to be refilled even when the brake pads are worn. If the level of brake fluid falls below the minimum value, this indicates a leak in the braking system or completely worn out brake pads. Arrange for the braking system to be checked by a Husaberg specialist, as complete failure of the braking system can be avoided.

Also check the state of the brake hose and the thickness of the brake linings.

Check free travel at the hand brake lever and foot brake lever.

6 CABLES

Check correct setting and easy running of all control cables.

7 COOLING FLUID

Check the level of the cooling fluid when the engine is cold.

8 ELECTRICAL SYSTEM

Check correct functioning of headlamps, tail-lights, brake lights, indicators, control lamps and horn while the engine is running.

9 LUGGAGE

If you are taking luggage with you, check that this is securely fastened.

10 REAR MIRROR

Checking the rear mirror setting.

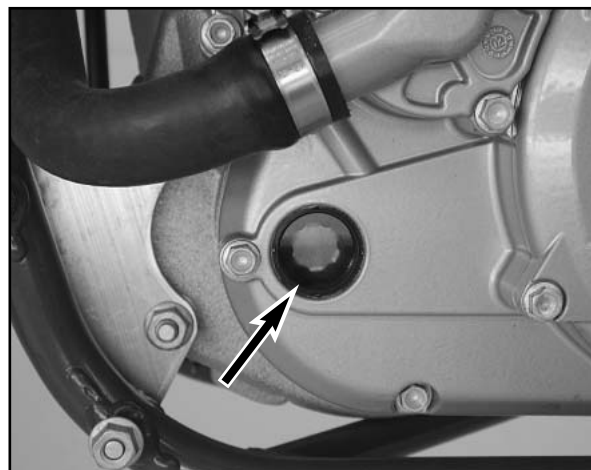

DRIVING INSTRUCTIONS

STARTING WHEN THE ENGINE IS COLD

- 1 Open the fuel taps (1).
- 2 Swing up the side stand or center stand.
- 3 Put the gear in neutral.
- 4 Operate the choke (2).
- 5 Leave throttle closed and kick the kickstarter briskly ALL THE WAY or actuate the E-starter.



WARNING: If you want to start the engine, make sure that you always put on sturdy motorcycle boots in order to avoid injuries. You might slip off the kickstarter, or the engine may kick back and propel your foot upward with great force.

Always kick the kickstarter briskly all the way without opening the throttle. If you do not Kick hard enough, with an open throttle grip, the kick-back hazard will be higher.

Do not start the engine and allow it to idle in a closed area. Exhaust fumes are poisonous and can cause loss of consciousness and death. Always provide adequate ventilation while the engine is running.

Always verify that the transmission has been set to idle (neutral) before actuating the starter button. If you start the motorcycle with a gear engaged, the motorcycle will move forward.



CAUTION: Be sure to kick up the side stand before you start the engine to avoid any damage.

Maximal period for continuous starting: 5 seconds. Wait at least 5 seconds before trying again.

Don't ride your motorcycle with full load and don't rev up the engine when cold because the piston is warming up faster than the water cooled cylinder and can cause engine damage.



NOTE: If it is difficult to start the engine, this could be due to old fuel in the float chamber. The highly inflammable constituents in the new fuel volatilize if left standing over longer periods of time. If the motorcycle was not used for over 1 week, drain the old fuel from the float chamber. The engine will start immediately after the float chamber is filled with fresh ignitable fuel.

STARTING WHEN THE ENGINE IS WARM

- 1 Open the fuel tap (1).
- 2 Swing up the side stand.
- 3 Put the gear in neutral.
- 4 Leave throttle closed and kick the kickstarter briskly ALL THE WAY or actuate the E-starter.



NOTE: Pull the hot start knob if the engine won't start.

WHAT TO DO WHEN THE ENGINE IS "FLOODED"

In the event of a fall, more fuel than necessary may get into the engine. In order to "pump the engine free", pull the hand decompression lever, fully rev up the engine, actuate the kickstarter 5 to 10 times or actuate the E-starter 2 times for 5 seconds each. Then, start the engine as described above.

If the engine fails to start, unscrew the spark plug and dry it.



NOTE: The carburetor has an accelerator pump. Every time you open the throttle, fuel will be injected into the intake passage. When starting, be sure that you open the throttle completely only once.

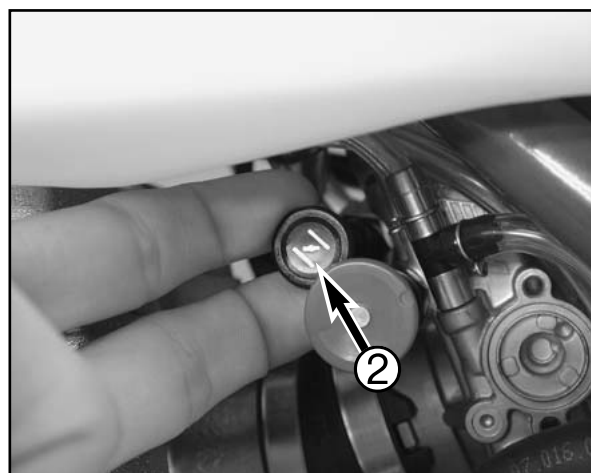
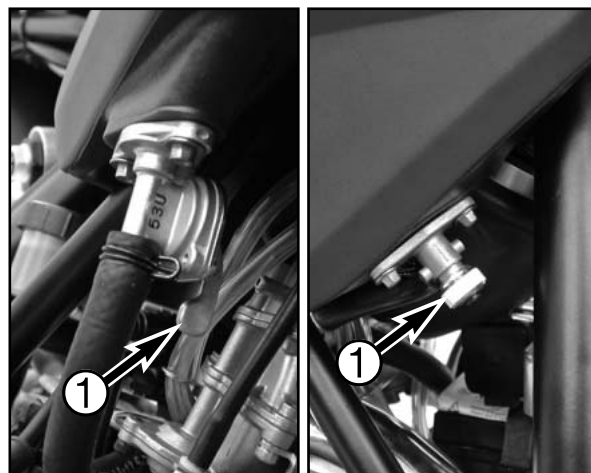

DRIVING INSTRUCTIONS

STARTING OFF

Pull the clutch lever, engage 1st gear, slowly release the clutch lever while you open the throttle.



WARNING: Always make sure the side stand is folded all the way up before driving off. The motorcycle can go out of control if the side stand touches the ground.

SHIFTING/RIDING

You are now in first gear, referred to as the drive or uphill gear. Depending on the conditions (traffic, hill size, etc.), you can shift to a higher gear. Close throttle, at the same time pull clutch lever in and shift to the next higher gear. Let clutch lever go again and accelerate. If you turned on the choke, make sure you turn it off again as soon as engine is warm.

When you reach full speed through opening the throttle all the way, turn throttle back to 3/4; the speed hardly decreases although the engine will use less gas. Only give as much gas as the engine can handle. Through quick and high revving of the throttle, the fuel usage increases.

By shifting down, use the brakes if necessary and close the throttle at the same time. Pull the clutch lever and shift down to the next gear. Let clutch lever go slowly and open the throttle or shift down again



NOTE: Dedicated to nothing but offroad racing, Husaberg models make no compromises in their design. As such, they do not include any radiator fan, and the size of the radiator is dimensioned for optimum ergonomics. In normal racing, the cooling system is sufficient. If you use your motorbike in other conditions, please note that: the E-starter allows you to start FS models again at any time. Therefore, turn off the engine if you intend to run your motorcycle in idle or at a standstill for longer periods of time (more than 2 minutes). Avoid letting the clutch slip frequently and for extended periods. This would cause the engine oil to heat up, thereby heating up the cooling system. You should drive at low speeds (4-stroke style - letting the engine pull you) and not at high speeds not by letting the clutch slip (2-stroke style).



WARNING: After falling with the motorcycle, check all functions thoroughly before starting up operations again.

A twisted handlebar must always be replaced. Do not adjust the handlebar, it will lose stability.



CAUTION: High rpm rates when the engine is cold have an adverse effect on the life of your engine. We recommend you run the engine in a moderate rpm range for a few miles giving it a chance to warm up. After that no further precautions in this respect need to be taken. The engine has reached its operating temperature as soon as the radiators become warm.

Never have the throttle wide open when changing down to a lower gear. The engine will over-rev, damaging the valves. In addition, the rear wheel locks so that the motorcycle can easily get out of control.

If any abnormal vibrations occur while driving, check that the engine fastening bolts are tight.

In the event that, while riding on your motorcycle, you notice any unusual operation-related noise, stop immediately, turn the engine off, and contact an authorized Husaberg dealer.

BRAKING

Close the throttle and apply the hand and foot brake simultaneously. Be especially careful when applying the brakes on sandy, wet or slippery surfaces. Always brake with feeling, locked wheels will cause the motorcycle to skid or crash. Always shift down the gears in accordance with the speed. Always finish braking before you enter a curve.

When driving down hill, use the braking effect of the engine. Change down one or two gears but do not overspeed the engine. In this way, you will not need to brake so much and the brakes will not overheat.



WARNING: In case of rain, after washing the motorcycle, after rides through water and in case of rides on wet off-road tracks, humid or dirty brake discs can delay the braking effect. The brakes must be pulled until they are dry or clean.

Rides on salt-strewn or dirty roads can also delay the braking effect. The brakes must be pulled until they are clean.

Dirty brake discs cause increased tear of brake pads and brake discs.

When you brake, the brake discs, brake pads, brake caliper and brake fluid heat up. The hotter these parts get, the weaker the braking effect. In extreme cases, the entire braking system can fail.

If the resistance in the hand brake lever or foot brake pedal feels "spongy" (too much play), this is an indication that something is wrong with the brake system. Don't ride your motorcycle anymore without first having the brake system looked over by a Husaberg dealer.

DRIVING INSTRUCTIONS

STOPPING AND PARKING

Decelerate and switch the engine into neutral. To switch off the engine at idling speed, press the short-circuit switch or the emergency off switch until the engine is off. Close the fuel taps, park the motorcycle on a firm surface and lock.



WARNING: Motorcycle engines produce a great amount of heat while running. The engine, exhaust pipe, muffler, brake rotors, and shock absorbers can become very hot. Do not touch any of these parts after operating the motorcycle, and take care to park it where pedestrians are not likely to touch it and get burned.



CAUTION: Do not use the hand decompressor lever to switch off the engine. Always use the short-circuit switch, the emergency off switch.

Close the fuel tap when leaving your vehicle. Otherwise the carburettor can flood and fuel will enter the engine.

Never park your motorcycle in places where there are fire hazards due to dry grass or other easily flammable materials.



NOTE REGARDING THE SIDE STAND: Use your foot to kick side stand forward up to the stop and lean the motorcycle sideways. Make sure that the ground is solid and that your motorcycle is standing securely. Just in case, you can shift into first gear. For off-road riding, you can use the rubber band to additionally secure the center stand in its folded-up position



CAUTION: The side stand is designed to bear only the load of the motorcycle. The side stand and/or the frame can be damaged and the motorcycle can fall over if you mount the motor-cycle, thus putting an additional load on the side stand.

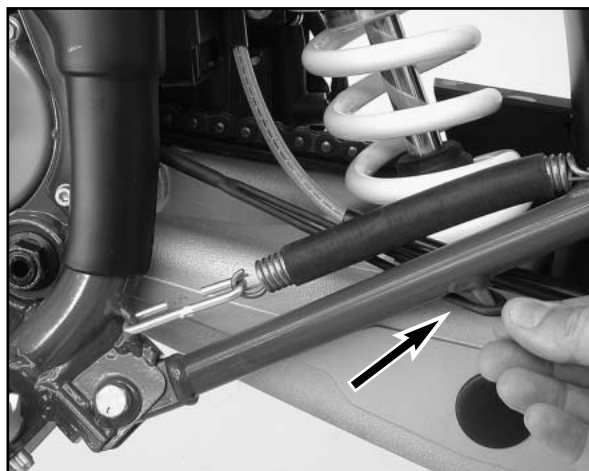

FUEL

The engine needs unleaded fuel with at least RON 95 (USA = Premium PON 91).



CAUTION: Use leaded or unleaded premium grade gasoline (95 octanes). Never use gasoline having less than 95 octanes because it may damage the engine.



WARNING: Gasoline is highly flammable and poisonous. Extreme caution should be used when handling gasoline. Do not refuel the motorcycle near open flames or burning cigarettes. Always switch off the engine before refuelling. Be careful not to spill gasoline on the engine or exhaust pipe while the engine is hot. Wipe up spills promptly. If gasoline is swallowed or splashed in the eyes, seek a doctor's advice immediately.

Fuel expands when its temperature rises. Therefore do not fill the tank to the top (see fig.).

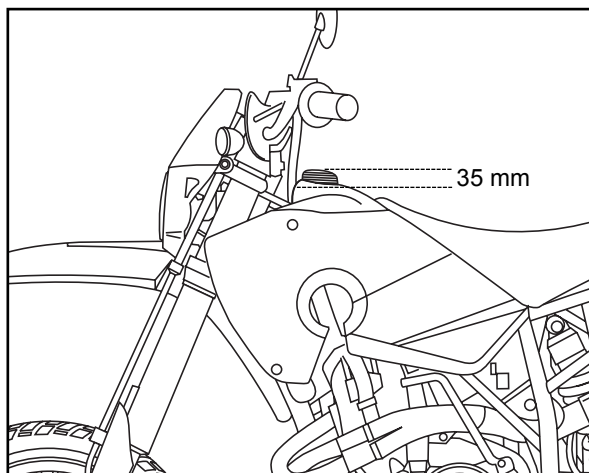

PERIODIC MAINTENANCE SCHEDULE

ENGLISH

FE 450, 550, 650 FS 450, 650		1. service after 3 hours or 20 l fuel	after/every 15 hours or 100 l fuel
A clean motorcycle can be checked more quickly which saves money!			
ENGINE	Change engine oil and oil filter	●	●
	Clean oil screen and drain plug magnet	●	●
	Replace spark plug (after 30 hours)		
	Check and adjust valve clearance	●	●
	Check engine mounting bolts for tightness	●	●
CARBURETOR	Check carburetor connection boot for cracks and leaks		●
	Check idle speed setting	●	●
	Check vent hoses for damage or bends	●	●
ADD-ON-PARTS	Check cooling system for leaks, check quantity of antifreeze	●	●
	Check exhaust system for leaks and fitment		●
	Check cables for damage, smooth operation and bends adjust and lubricate	●	●
	Check fluid level of the clutch master cylinder	●	●
	Clean air filter and filter box		●
	Check electric wires for damage and bends		●
	Check headlamp setting		●
	Check function of electric systems (low high beam, brake light, indicator lamps, speedometer illumination, horn, emergency OFF switch or button)	●	●
BRAKES	Check brake fluid level, lining thickness, brake discs	●	●
	Check brake lines for damage and leaks	●	●
	Check function and smooth operation and adjust free travel of handbrake/foot brake lever	●	●
	Check tightness of brake system screws	●	●
CHASSIS	Check shock absorber and fork for leaks and function	●	●
	Clean fork dust bellows		●
	Bleed fork legs		●
	Check swing arm bearings		●
	Check/adjust steering head bearings	●	●
	Check tightness of chassis screws (triple clamps, fork leg axle passage)	●	●
WHEELS	Check spoke tension and rim joint	●	●
	Check tires and air pressure	●	●
	Check chain, chain joint, rear sprockets and chain guides for wear, fit and tension	●	●
	Lubricate chain	●	●
	Check clearance of wheel bearings	●	●

IMPORTANT MAINTENANCE WORK THAT MUST BE CARRIED OUT BY EXTRA ORDER		at least once a year
Complete maintenance of fork		●
Complete maintenance of shock absorber		●
Clean and grease steering head bearings and gasket elements		●
Clean and adjust carburetor		●
Replace glass fibre yarn filling of the exhaust main silencer		●
Treat electric contacts and switches with contact spray		●
Treat battery connections with contact grease		●
Change hydraulic clutch fluid		●
Change brake fluid		●

IF MOTORCYCLE IS USED FOR COMPETITION 15 HOURS SERVICE SHOULD BE CARRIED OUT AFTER EVERY RACE. Service intervals should never be exceeded by more than 2 hours or 15 liters of fuel. Maintenance work done by Husaberg authorised workshops is not a substitute for care and checks done by the rider.

PERIODIC MAINTENANCE SCHEDULE

IMPORTANT CHECKS AND MAINTENANCE TO BE CARRIED OUT BY THE RIDER			
	Before each start	After every cleaning	For cross-country use
Check oil level	•		
Check brake fluid level	•		
Check brake pads for wear	•		
Check lights for function	•		
Check horn for function	•		
Lubricate and adjust cables and nipples		•	
Bleed fork legs regularly			•
Remove and clean fork dust bellows regularly			•
Clean and lubricate chain, check tension and adjust if necessary		•	•
Clean air filter and filter box		•	•
Check tires for pressure and wear	•		
Check cooling fluid level	•		
Check fuel lines for leaks	•		
Drain and clean float chamber		•	
Check all control elements for smooth operation	•		
Check brake performance	•	•	
Treat blank metal parts (with the exception of brake and exhaust system) with wax-based anti corrosion agent		•	
Treat ignition and steering locks and light switches with contact spray		•	
Check tightness of screws, nuts and hose clamps regularly			•

INSPECTION OF THE HUSABERG - ENGINES USED FOR HOBBY-ENDURO COMPETITIONS BY YOUR HUSABERG WORKSHOP (ADDITIONAL ORDER FOR THE HUSABERG WORKSHOP)							
a 100 liter fuel consumption is equivalent to approx. 15 operating hours	30 hours 200 liter	60 hours 400 liter	90 hours 600 liter	120 hours 800 liter	180 hours 1200 liter	240 hours 1600 liter	270 hours 1800 liter
Check the clutch disks for wear	•	•	•	•	•	•	•
Check the length of the clutch springs		•	•	•	•	•	•
Check the cylinder and piston for wear			•		•		•
Check the groove on the piston pin retainer for wear (visual check)			•		•		•
Check the camshaft for wear (visual check)			•		•		•
Check the camshaft bearings			•		•		•
Check the length of the valve springs			•		•		•
Check the spring cap for wear			•		•		•
Check the eccentricity of the valve disk			•		•		•
Check the valve guides for wear			•		•		•
Check the radial clearance of the rocker arm rollers			•		•		•
Check the elongation of the timing chain			•		•		•
Check the chain tensioner tooting for damage (visual check)		•	•	•	•	•	•
Check the eccentricity of the crankshaft journal		•		•		•	
Replace the conrod bearings		•		•		•	
Check piston pin bearing		•		•		•	
Replace the balancer shaft bearings		•		•		•	
Replace the crankshaft main bearings		•		•		•	
Check the entire transmission including the roller and bearings for wear		•		•		•	

ENGLISH

PERIODIC MAINTENANCE SCHEDULE

INSPECTION OF THE HUSABERG - ENGINES USED FOR ENDURO COMPETITIONS BY YOUR HUSABERG WORKSHOP (ADDITIONAL ORDER FOR THE HUSABERG WORKSHOP)

a 100 liter fuel consumption is equivalent to approx. 15 operating hours	15 hours 100 liter	30 hours 200 liter	45 hours 300 liter	60 hours 400 liter	90 hours 600 liter	120 hours 800 liter	135 hours 900 liter
Check the clutch disks for wear	●	●	●	●	●	●	●
Check the length of the clutch springs		●	●	●	●	●	●
Check the cylinder and piston for wear			●		●		●
Check the groove on the piston pin retainer for wear (visual check)			●		●		●
Check the camshaft for wear (visual check)			●		●		●
Check the camshaft bearings			●		●		●
Check the length of the valve springs			●		●		●
Check the spring cap for wear			●		●		●
Check the eccentricity of the valve disk			●		●		●
Check the valve guides for wear			●		●		●
Check the radial clearance of the rocker arm rollers			●		●		●
Check the elongation of the timing chain			●		●		●
Check the chain tensioner tooting for damage (visual check)		●	●	●	●	●	●
Check the eccentricity of the crankshaft journal			●		●		●
Replace the conrod bearings			●		●		●
Check piston pin bearing			●		●		●
Replace the balancer shaft bearings			●		●		●
Replace the crankshaft main bearings			●		●		●
Check the entire transmission including the roller and bearings for wear			●		●		●

ENGLISH

PERIODIC MAINTENANCE SCHEDULE

 **WARNING: MAINTENANCE AND ADJUSTING WORK MARKED WITH AN ASTERISK (*) REQUIRES EXPERT SKILLS AND TECHNICAL KNOW-HOW. FOR YOUR OWN SAFETY, ALWAYS HAVE SUCH WORK PERFORMED BY A SPECIALIZED HUSABERG DEALER WHERE YOUR MOTORCYCLE WILL BE OPTIMALLY SERVICED BY APPROPRIATELY QUALIFIED, SKILLED STAFF.**

 **CAUTION: If using a power washer, do not point the water jet at the electric components, plugs, cables, bearings, carburetor, etc. The high pressure will cause water to penetrate into the components and can cause them to malfunction or lead to premature wear.**

When transporting your Husaberg, ensure that it is held upright with restraining straps or other mechanical fastening devices and that the fuel tap is in the OFF position - if the motorcycle should fall over, no fuel can leak from the carburetor or fuel tank

Do not use toothed washers or spring rings with the engine fastening screws, as these work into the frame parts and keep working loose. Instead, use self-locking nuts.

Let your motorcycle cool down before beginning any maintenance work in order to avoid getting burned.

Dispose oils, fatty matters, filters, fuels, washing detergents etc. properly.

Under no circumstances may used oil be disposed of in the sewage system or in the open countryside. 1 liter of used oil contaminates 1,000,000 liters of water.

ENGLISH

CHECKING AND ADJUSTING THE STEERING HEAD BEARING *

The steering head bearing should be checked regularly for play. For this purpose, jack up the motorcycle by the frame so that the front wheel is in the air. Now try to move the fork forward and backward. There should be no clearance. For readjustment, release the 4 clamp screws (1) of the top triple clamp and the steering head nut (2). Turn the adjusting nut (3) until almost no play is left. Do not tighten the adjusting nut! Tightening the adjusting nut can damage the bearings! Tighten the steering head nut to 20 Nm and the 4 clamping screws to 17 Nm.

 **WARNING: If the steering head bearing is not adjusted to be free of play, the motorcycle will exhibit unsteady driving characteristics and can get out of control.**

If the steering head nut is not tightened to the prescribed torque, the motorcycle will exhibit unsteady driving characteristics and can get out of control.

 **CAUTION: If you drive with play in the steering head bearing for longer periods, the bearings and subsequently the bearing seats in the frame will be destroyed.**

If the steering head nut is not tightened to the prescribed torque, the triple clamp and steering stem may be damaged.

The steering head bearings should be regreased at least once a year (e.g. Motorex Long Term 2000).

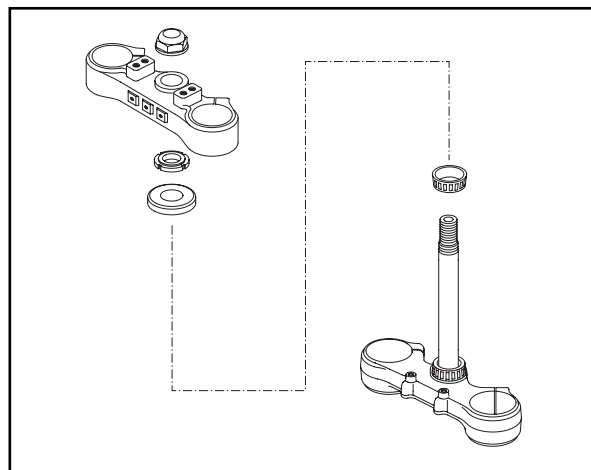
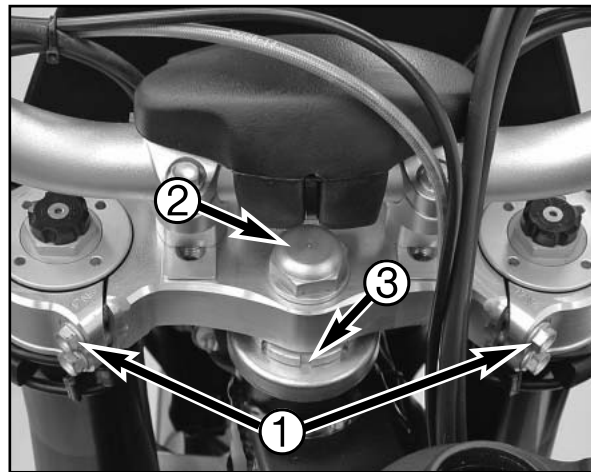

MAINTENANCE WORK ON CHASSIS AND ENGINE

BREATHER PLUG FRONT FORK

After every 5 hours of use for competitive racing, slacken the breather plugs (1) a few turns in order to relieve excess pressure from the inside of the fork. To do this, place the motorcycle on a stand with the front wheel lifted off the ground. When riding the motorcycle mainly on the road, it will suffice to have this job performed in the course of the periodical maintenance service.



CAUTION: Excessive pressure in the interior of the fork can cause leaks in the fork. If your fork is leaking, it is recommended to open the breather plugs before having the seals replaced.

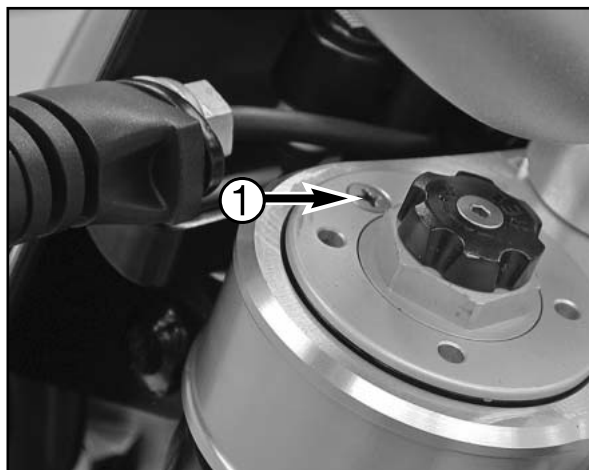

CLEANING THE DUST SLEEVES OF THE TELESCOPIC FORK

The dust-protection bellows (2) are to remove dust and coarse dirt particles from the fork tube. However, after some time, dirt may also get in behind the dust-protection bellows. If this dirt is not removed, the oil sealing rings located behind it may start to leak.

Use a screwdriver to lift the dust-protection bellows out of the outer tubes and slide them downward.

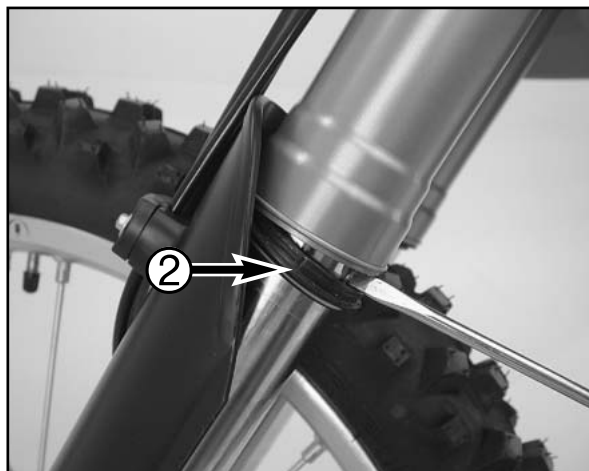

Pry the dust boots out of the outer pipes with a screwdriver and slide down. Clean dust boots, outer pipes and fork tubes thoroughly. Oil generously with Universal oil spray (Motorex Joker 440) or engine oil. Press the dust boots into the outer pipes by hand.



WARNING: No oil may reach the front tire or the brake disk since this would considerably reduce the tire's road grip and the braking effect of the front brake.

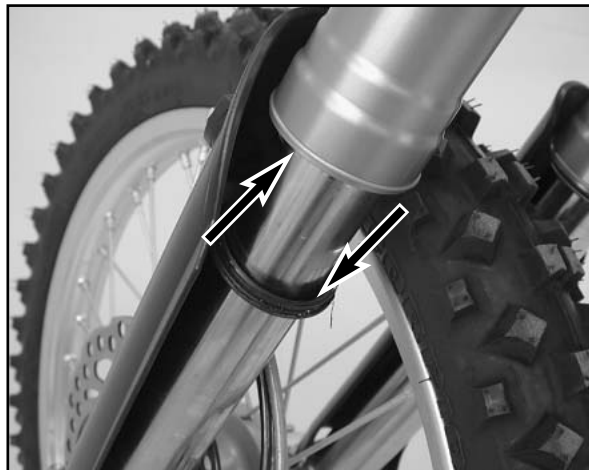

MAINTENANCE WORK ON CHASSIS AND ENGINE

BASIC SUSPENSION SETUP FOR THE WEIGHT OF THE DRIVER

To achieve maximum handling performance and to prevent the fork, shock absorber, swing arm and frame from being damaged, the basic setup of the suspension components must be suitable for your weight. At delivery, Husaberg's offroad motorcycles are set to accommodate a driver weighing 75 - 85 kg (wearing full protective clothing). If your weight exceeds or falls short of this range, you will need to adjust the basic setup for the suspension components accordingly. Minor deviations in weight can be compensated by adjusting the spring preload. Different springs must be installed for larger deviations.

CHECKING THE SHOCK ABSORBER AND SPRING

You can establish whether or not the shock absorber spring is suitable for your weight by checking the riding sag. The static sag must be correctly adjusted before the riding sag can be determined.

DETERMINING THE STATIC SAG OF THE SHOCK ABSORBER

The static sag should be as close as possible to 35 mm (FE) or 20 mm (FS). Deviations of more than 2 mm can strongly influence the motorcycle's performance.

Procedure:

- Jack up the motorcycle until the rear wheel no longer touches the ground.
- Measure the vertical distance between the rear wheel axle and a fixed point (e.g. a mark on the side cover) and write it down as dimension A.
- Place the motorcycle on the ground again.
- Ask a helper to hold the motorcycle in vertical position.
- Measure the distance between the rear axle and the fixed point again to establish dimension B.
- The static sag is the difference between dimensions A and B.

EXAMPLE:

Motorcycle jacked up (dimension A)	600 mm
Motorcycle on ground, unloaded (dimension B)	565 mm
Static sag	35 mm

If the static sag is lower, the spring preload of the shock absorber must be reduced, if the static sag is higher, the spring preload must be increased. See chapter "Changing the spring preload of the shock absorber."

DETERMINING THE RIDING SAG OF THE SHOCK ABSORBER

- Have a helper hold the motorcycle while you sit on the bike in a normal seating position (feet on the footrests) wearing full protective clothing and bounce up and down a few times to allow the rear wheel suspension to become level.
- Stay on the bike and have another person measure the distance between the same two points and write it down as dimension C.
- The riding sag is the difference between dimensions A and C.

EXAMPLE:

Motorcycle jacked up (dimension A)	600 mm
Motorcycle on ground, loaded (dimension C)	500 mm
Riding sag	100 mm

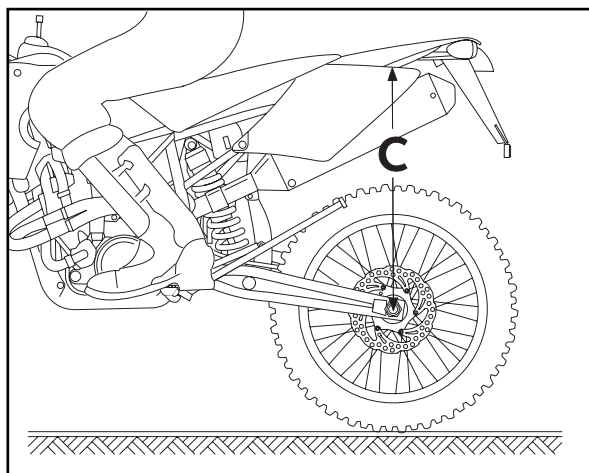
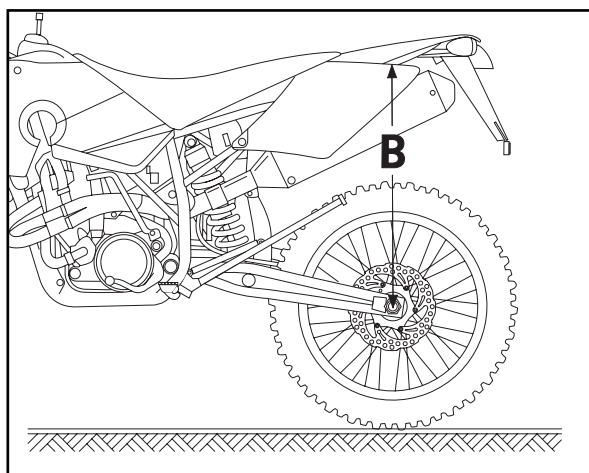
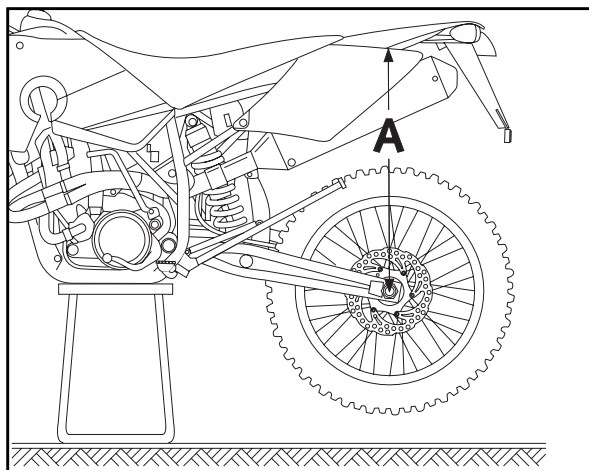

ENGLISH

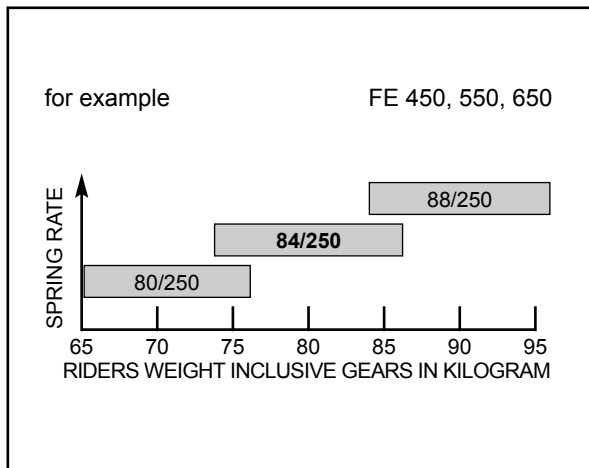

MAINTENANCE WORK ON CHASSIS AND ENGINE

The riding sag should lie between 95 - 105 mm (FE) or 85 - 95 mm (FS). If the riding sag is less than 95 mm (FE) or 85 mm (FS), the spring is too hard (the spring rate is too high). If the riding sag is more than 105 mm (FE) or 95 mm (FS), the spring is too soft (the spring rate is too low). The spring rate is written on the outside of the spring (e.g. 88/250). The type number of the shock absorber is embossed on the bottom of the tank. The illustrations show which spring should be installed. The standard spring is shown in bold print. After installing a different spring, readjust the static sag to 35 mm ± 2 mm (FE) or 20 mm ± 2 mm (FS). According to our experience, the damping rate of the compression stage can remain unchanged. The damping rate of the rebound stage can be reduced by a few clicks for a softer spring or increased by a few clicks for a harder spring.

MODELL	SOFTER	STANDARD	HARDER
12457D02 FE 450,550,650	80/250	84/250	88/250
12457D03 FS 450,650	84/250	88/250	92/250

CHECKING THE BASIC SETUP OF THE TELESCOPIC FORK

The precise riding sag of the telescopic fork cannot be determined for various reasons. Similar to the shock absorber, smaller deviations in your weight can be compensated by adjusting the spring preload. However, if your telescopic fork bumps frequently (hard end stop during compression), you should install harder fork springs to avoid damaging the telescopic fork and frame.

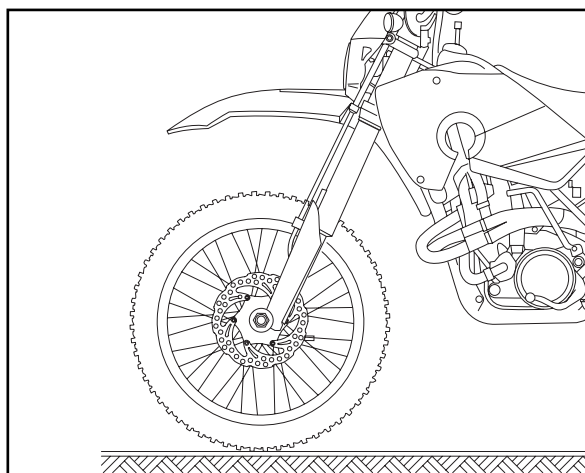

CHANGING THE SPRING PRELOAD ON THE TELESCOPIC FORK (see page 16)

REPLACING FORK SPRINGS

If you weigh less than 75 kg or more than 85 kg, you should install the respective fork springs. The correct spring rate is shown in the illustrations. The standard spring is shown in bold print. The type number of the telescopic fork is embossed on the caps on the top of the telescopic fork. If you are uncertain which spring to use, contact your Husaberg workshop.

According to our experience, the damping rate of the compression stage can remain unchanged. The damping rate of the rebound stage can be reduced by a few clicks for a softer spring or increased by a few clicks for a harder spring.

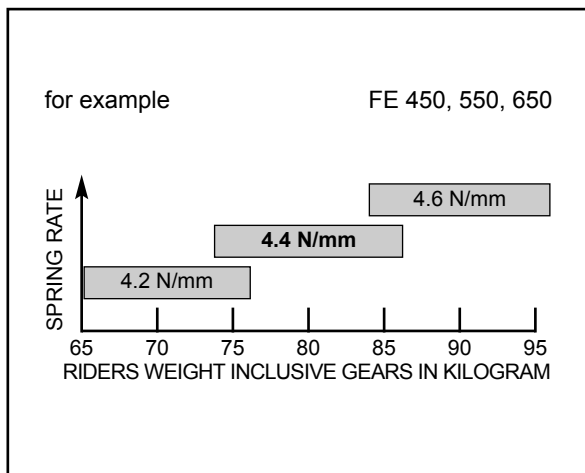

MODELL	SOFTER	STANDARD	HARDER
14457D02 FE 450,550,650	4.2 N/mm	4.4 N/mm	4.6 N/mm
14457D03 FS 450,650	4.4 N/mm	4.6 N/mm	4.8 N/mm

MAINTENANCE WORK ON CHASSIS AND ENGINE

CHANGING THE FORK OFFSET (CASTER) *

The fork offset (**A**) in these models (center fork legs - center steering head angle) can be changed. This allows you to optimize the handling to match the race course.

You can see which offset is preset when you remove the end screw (**1**). If the flat area (**B**) is in the rear, the offset is 16 mm (FS) or 20 mm (FE). This setting will improve driving stability on fast race courses.

If the flat area (**B**) is in the front, the offset is 18 mm (FS) or 22 mm (FE). This setting will improve the handling in curves.

The offset is set to 16 mm (FS) or 22 mm (FE) in the condition at delivery.

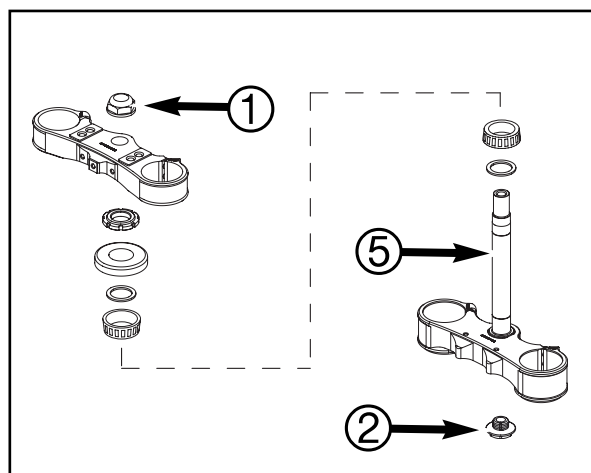
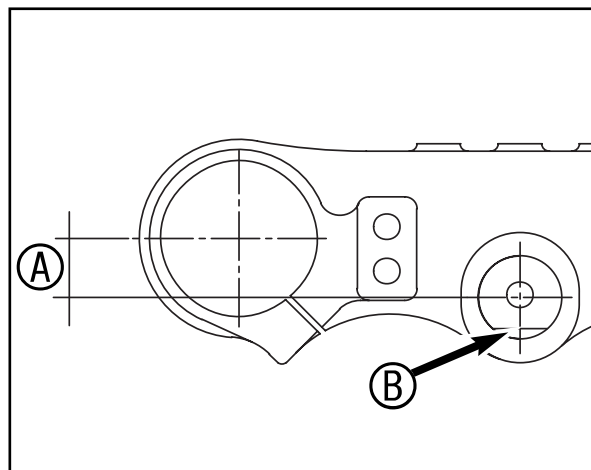

To adjust the offset, dismount the front wheel and remove the front wheel fender.

Remove the headlight mask and disconnect the plug connector from the brake light switch and speedometer sensor.

Remove the clamp screws on the hand brake cylinder and fasten the hand brake cylinder to the left fork leg with a cable tie to keep the brake line from kinking (see illustration).



Loosen the clamp screws and take the fork legs out of the triple clamps. Loosen the collar screw (**2**) on the lower triple clamp 2 turns.

Remove the end screw (**1**) from the upper triple clamp and rest the upper triple clamp on the tank. Remove the adjusting nut (**3**) and protection ring (**4**).

Tap gently on the lower triple clamp with a rubber hammer to loosen the steering stem (**5**) out of the bearing seat. Take the lower triple clamp with the steering stem out of the steering head.

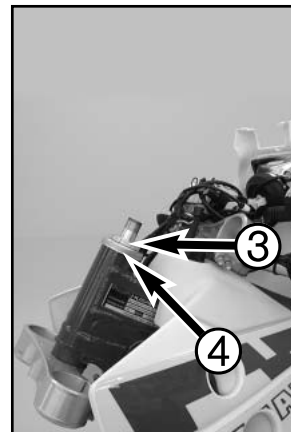
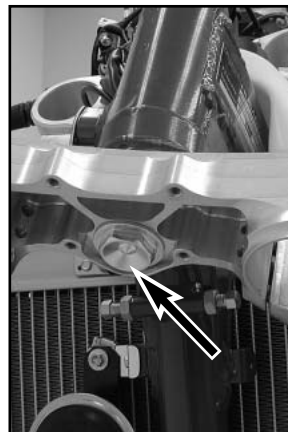

MAINTENANCE WORK ON CHASSIS AND ENGINE

Remove the collar screw from the lower triple clamp and pull out the steering stem. Thoroughly clean all parts. Turn the steering stem 180° and insert it in the triple clamp. Apply Loctite 243 to the thread of the collar screw (2) and turn all the way in.



WARNING: Be sure to lock the thread on the collar screw (2) with Loctite 243.

Grease the steering head bearing and sealing elements.



Mount the lower triple clamp, protection ring, adjusting nut, upper triple clamp and the end screw.

Tighten the collar screw on the lower triple clamp to 60 Nm.

Mount the fork legs and tighten the clamp screws on the lower triple clamp to 12 Nm in 3 stages.

Adjust the steering head bearing without clearance (see: Checking and adjusting the steering head support) and tighten the clamp screws on the upper triple clamp to 17 Nm in 3 stages.



Mount the front wheel fender and tighten the screws to 10 Nm.

Mount the hand brake cylinder and tighten the screws to 10 Nm.

Connect the plug connector for the brake light switch and speedometer sensor and mount the headlight mask.

Mount the front wheel (see: Dismounting and mounting the front wheel).



MAINTENANCE WORK ON CHASSIS AND ENGINE

HOW TO CHANGE THE HANDLEBAR POSITION

The handlebar position can be readjusted by 22 mm. Thus, you can put the handlebar in the position that is the most convenient for you. The upper triple clamp (1) includes 2 bores arranged at a distance of 15 mm (0.6 in) from one another. The bores at the handlebar support (2) are offset from the center by 3.5 mm (0.13 in). Accordingly, you can mount the handlebar in 4 different positions.

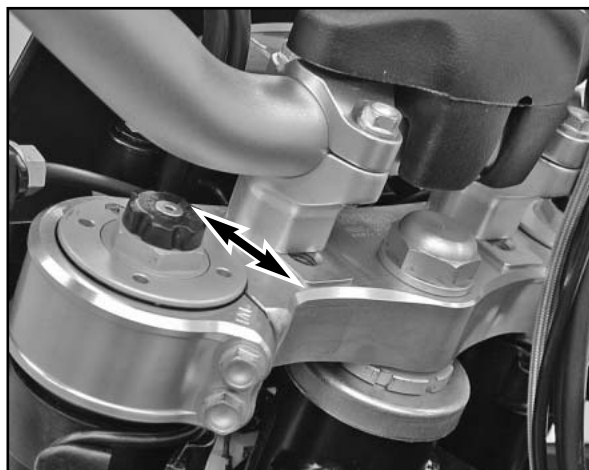

For this purpose, remove screws (3) of the handlebar clamps and screws (4) of the handlebar support. Position the handlebar support, and tighten screws (4) to 40 Nm. Mount handlebar and handlebar clamps, and tighten screws (3) to 20 Nm. The gap between the handlebar support and the handlebar clamps should be the same in the front and in the rear.

 **WARNING:** The screws (4) must be secured with Loctite 243.

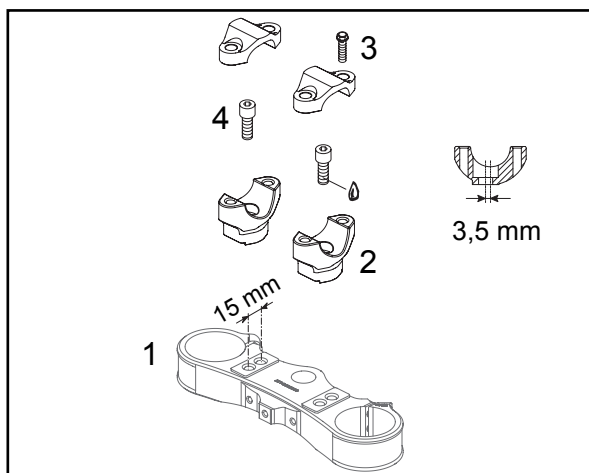

CHANGING THE SPRING PRELOADING OF THE SHOCK ABSORBER

The spring preload can be changed by turning the adjusting ring (5). For this purpose, you should dismount the shock absorber and clean it thoroughly.

NOTE:

- Before changing the spring preload note down the basic setting, e.g. how many threads are visible above the adjusting ring.
- One rotation of the adjusting ring (5) changes the spring pretension by approximately 1 mm (0.04 in).

Loosen the clamping screw (6) and use the hook wrench contained in the vehicle tool set to turn the adjusting ring as desired. Turning it counter-clockwise will reduce the preload, turning it clockwise will increase the preload.

After readjusting the clamping screw (6), tighten it to 8 Nm.

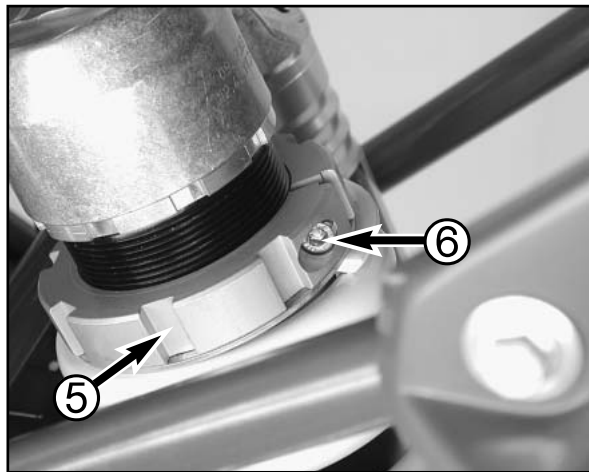

ADJUSTMENT VALUES - SPRING PRELOAD (A)

minimum preload4 mm
STANDARD PRELOAD (FE 450,501,550,650)5 mm
STANDARD PRELOAD (FS 450,650)11 mm
maximum preload12 mm

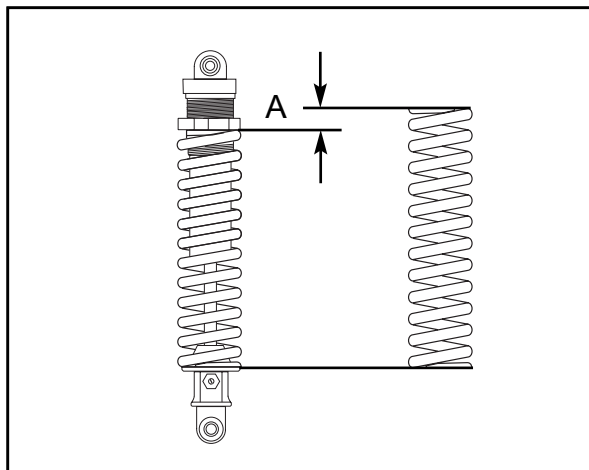

MAINTENANCE WORK ON CHASSIS AND ENGINE

CHECK CHAIN TENSION

Jack the motorcycle up on its frame so that the rear wheel no longer touches the ground.

Press the chain upward at the end of the chain sliding component. The distance between the chain and the swing arm should be approx. 8 - 10 mm (0.31 - 0.39 in). In the course of this procedure, the upper chain portion (A) must be taut (see drawing). If necessary, correct the chain tension.



WARNING: Excessive tensioning of the chain will put additional load on the components of the secondary drivetrain (chain, bearings of transmission and rear wheel). Aside from resulting premature wear, if worst comes to worst the chain may rupture or the countershaft of the transmission may break.

Too much slack in the chain, on the other hand, can result in the chain jumping off the chain wheels. If this happens, the chain could also block the rear wheel or damage the engine.

In either case the operator is likely to lose control of the motorcycle.

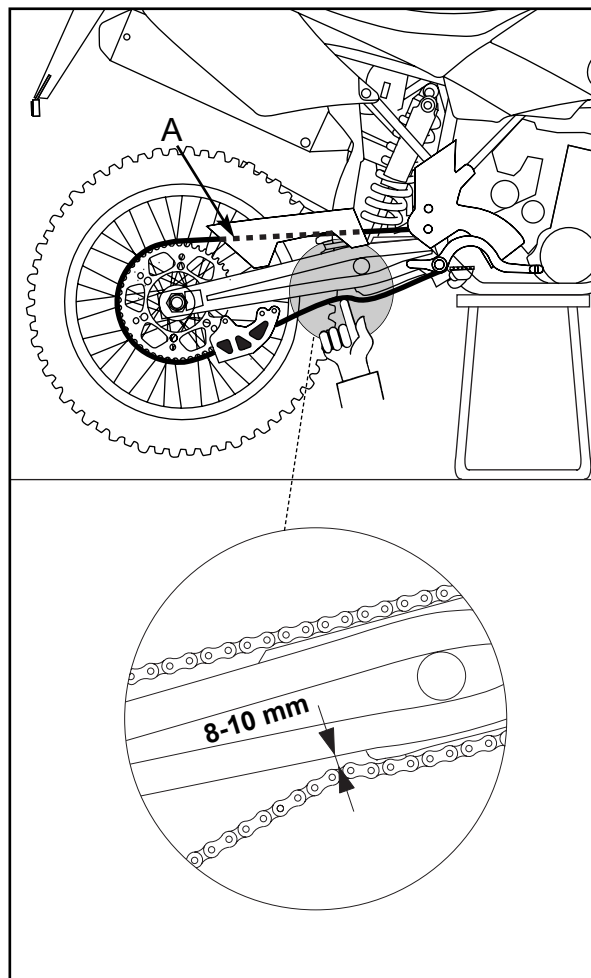

CORRECT CHAIN TENSION

Loosen collar nut (1), loosen lock nuts (2), and turn right and left adjusting screws (3) equally far. Tighten lock nuts.

To ensure the correct alignment of the rear wheel, the marks at the left and right chain adjusters must be positioned identically in relation to the reference marks (B). Tighten the counter nut of the adjusting screws.

Before tightening the collar nut, verify that the chain adjusters (4) are sitting close to the adjusting screws and that the rear wheel has been aligned with the front wheel.

Tighten collar nut (1) to 80 Nm.



WARNING: If you don't happen to have a torque wrench at hand, make sure you have the tightening torque corrected by a Husaberg dealer as soon as possible. A loose axle may lead to an unstable driving behavior of your motorcycle.

Tighten the collar nut with the required torque. A loose wheel spindle may lead to an unstable behavior of your motorcycle.



NOTE: The large adjusting range of the chain adjusters (32mm) allows you to use different secondary ratios in combination with the same chain length. The chain adjusters (4) can be rotated by 180°.

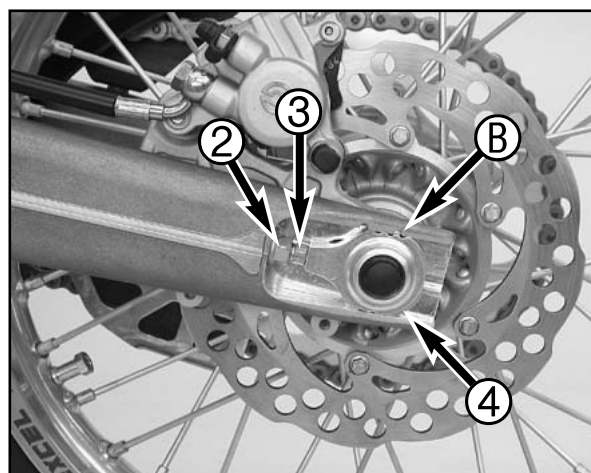
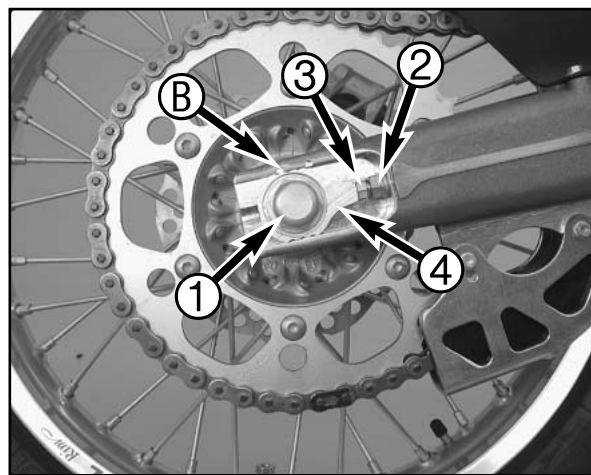

MAINTENANCE WORK ON CHASSIS AND ENGINE

CHAIN MAINTENANCE

For a long chain life, good maintenance is very important. Chains without X-rings should be cleaned in fireproof solvent regularly and afterwards treated with hot grease or chain spray (e.g. Motorex Chainlube 622). X-ring chains on the other hand are very simple to clean. The best way is to use lots of water, but never use brushes or cleaning liquids. After letting the chain dry, you can use a special X-ring chain spray (e.g. Motorex Chainlube 622).

 **WARNING:** No lubrication is allowed to reach the rear tire or the brake disks, otherwise the road adherence and the rear wheel braking effects would be strongly reduced and the motorcycle could easily lose control.

 **CAUTION:** mounting the chain masterlink clip, the closed side of the masterlink clip must point in running direction.

Also check sprockets and chain guides for wear and replace if necessary.

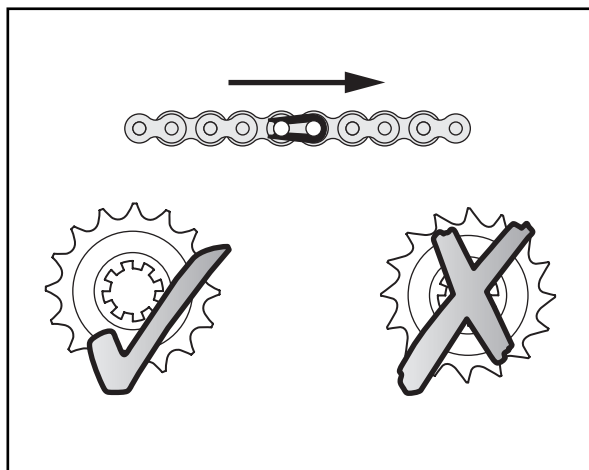

CHAIN WEAR

To check the chain wear, observe the following indications: Shift the gear into idling and pull the upper chain strand with approx. 10-15 Kilograms (33 lb) upwards (see figure). Now one can measure a space of 18 chain reels at the lower chain strand. The chain should be replaced at the latest when a space of 272 mm (10.70 in) is measured. Chains do not always wear off evenly, therefore repeat the measurement at different places on the chain.

 **NOTE:** If you mount a new chain, the sprockets should also be replaced. New chains wear faster if used on old used sprockets.

 **CAUTION:** Secure the screws of the chain wheel by applying Loctite and fasten them in a crosswise order. Tightening torque for nuts: 35 Nm. Tightening torque for screws: 50 Nm.

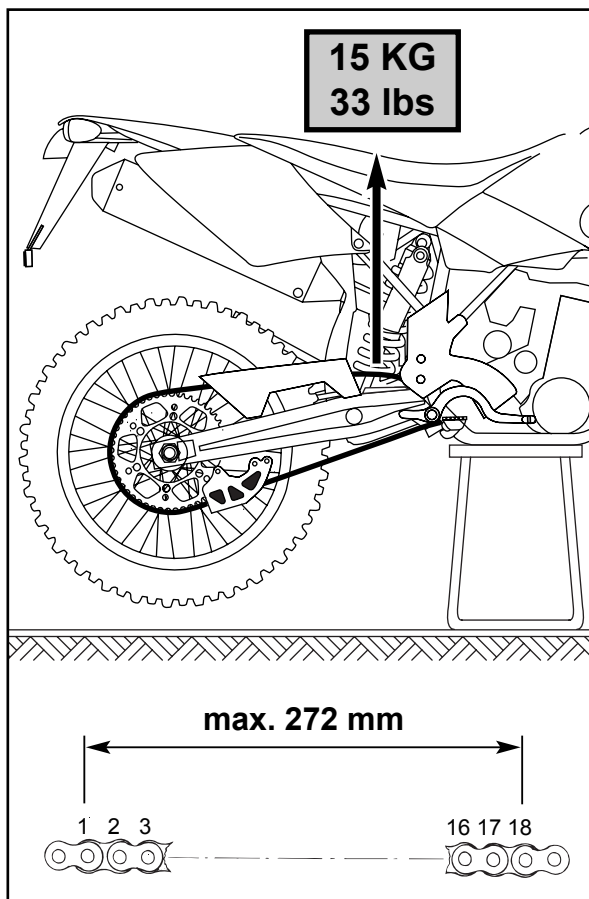

MAINTENANCE WORK ON CHASSIS AND ENGINE

GENERAL INFORMATION ABOUT HUSABERG DISC BRAKES

BRAKE CALIPERS:

Tighten the screws on the brake caliper support or the brake caliper to 25 Nm + Loctite 243 (FE) or to 40 Nm (FS).

BRAKE PADS:

The brake pads are fitted with TOSHIBA TT 2701(FE), BERINGER 1100S (FS) sintered lining at the front and ID450 sintered lining at the back. These linings provide an optimal combination of dosing, brake performance and life cycle. The lining type is stated on the back of the brake pad and also recorded in the homologation papers.

Other brake pads are available for competition sports.



BRAKE DISCS:

Wear will reduce the thickness of the brake disk around the mounting face (1) of the brake pads.



WARNING: Brake disks with less than the minimum thickness are a safety risk. Have the brake disk replaced as soon as it reaches the wear limit.

Always have repairs to the brake system performed by an authorized Husaberg shop.

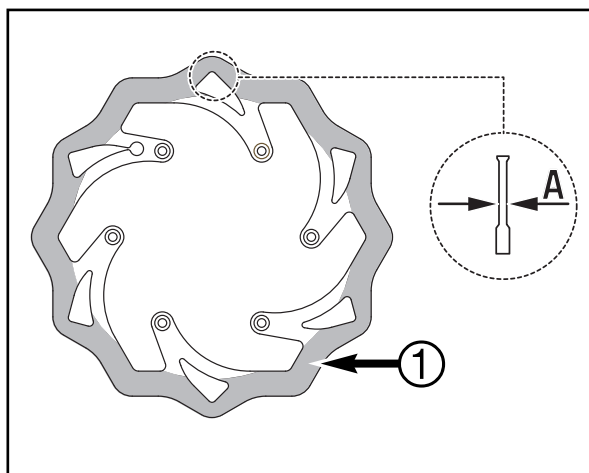

WEAR LIMIT (A) BRAKE DISKS:

front FE	2.5 mm
front FS	4.5 mm
rear FE	3.5 mm
rear FS	4.5 mm

BRAKE FLUID RESERVOIRS:

The brake fluid reservoirs on the front and rear wheel brakes have been designed in such a way that even if the brake pads are worn it is not necessary to top up the brake fluid. If the brake fluid level drops below the minimum level either the brake system has a leak or the brake pads are completely worn. In this case, consult an authorized Husaberg dealer immediately.

BRAKE FLUID:

Husaberg fills the brake systems with Motorex Brake Fluid DOT 5.1 brake fluid, one of the best brake currently available. We recommend that you continue to use it. DOT 5.1 brake fluid is based on glycol ether and of an amber color. If you do not have any DOT 5.1 for refilling, you may use DOT 4 brake fluid. However, you should replace it as soon as possible with DOT 5.1.

Never use brake fluid DOT 5. The color of this silicon oil-based product is purple red. The gaskets and brake hoses of Husaberg motorcycles are not designed for DOT 5 brake fluid.



WARNING: Have the brake fluid changed at least once annually. If you wash your motorcycle often, the brake fluid should be changed even more frequently. Brake fluid tends to absorb water. Therefore, vapor pockets may form in "old" brake fluids even at low temperatures, causing the brake system to fail.

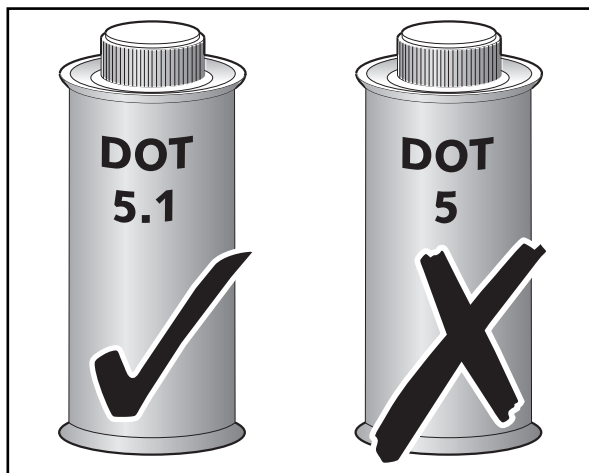

MAINTENANCE WORK ON CHASSIS AND ENGINE

CHANGING THE BASIC POSITION THE HAND BRAKE LEVER (FE)

Free travel at the hand brake lever may be readjusted by using adjustment screw (1). In this way, the position of the point of pressure (e.g. the resistance you feel on the hand brake lever when the brake pads are pressed against the brake disc) can be adjusted for any hand size. When you press the hand brake lever forwards, you should have at least 3 mm free travel. Turn the adjusting screw (1) if necessary.

 **CAUTION:** At the hand brake lever, free travel must at least be 3 mm (0.1 in). Only then may the piston in the hand brake cylinder be moved (to be recognized by the greater resistance of the hand brake lever). If this free travel is not provided, pressure will build up in the braking system, and the front-wheel brake may fail due to overheating.

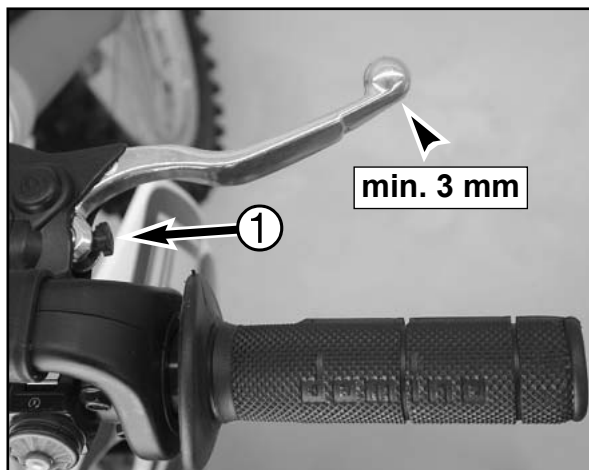

CHANGING THE BASIC POSITION THE HAND BRAKE LEVER (FS)

The adjusting screw (2) allows you to change the basic position of the handbrake lever (3).

Press the handbrake lever's outer end forward, and, at the same time, turn the adjusting screw.

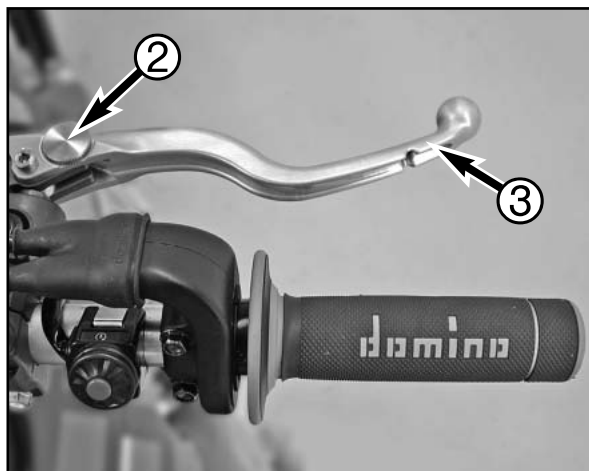

CHECKING THE BRAKE FLUID LEVEL - FRONT BRAKE

The brake fluid reservoir is linked with the hand brake cylinder at the handlebar and the reservoir is provided with an inspection glass. With the reservoir in a horizontal position, the brake fluid level should not drop below the middle of the glass.

 **WARNING:** If the brake fluid level drops below the minimum either the brake system has a leak or the brake pads are completely worn. In this case, consult an authorized Husaberg dealer immediately.

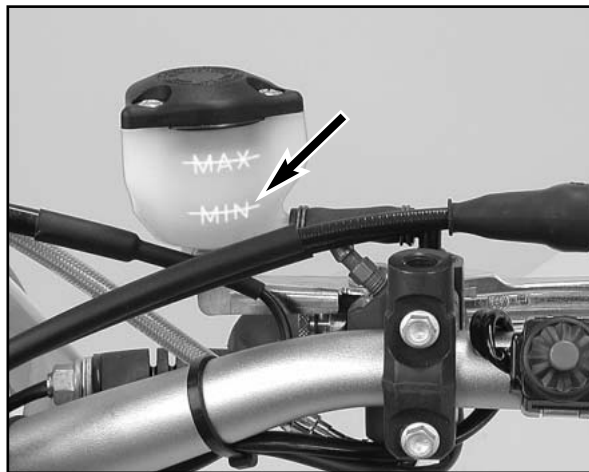

REFILLING THE FRONT BRAKE FLUID RESERVOIR *

Loosen screws (4) and remove lid (5) and membrane (6). Place hand brake cylinder in a horizontal position and fill the brake fluid reservoir to 5 mm (0.2 in) below the rim with clean brake fluid DOT 5.1 (e.g. Motorex Brake Fluid DOT 5.1). Replace membrane and lid, tighten screws. Rinse off spilled or overflowing brake fluid with water.

 **WARNING:** Never use DOT5 brake fluid! It is based on silicone oil and of a purple color. Seals and brake hoses must be especially adapted to it.

Store brake fluid out of reach of children.

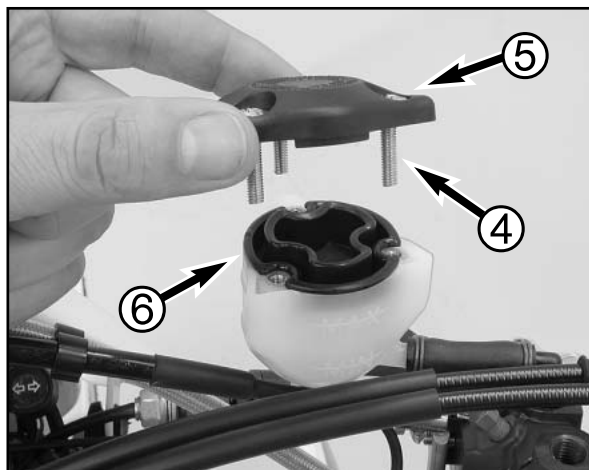

MAINTENANCE WORK ON CHASSIS AND ENGINE

 **WARNING:** Brake fluid can cause skin irritation. Avoid contact with skin and eyes. If you get brake fluid in your eyes, rinse with plenty of water and consult a doctor

 **CAUTION:** Don't let brake fluid get in contact with paint, it is an effective paint remover.

Use only clean brake fluid (not older than six months) taken from a tightly sealed container.

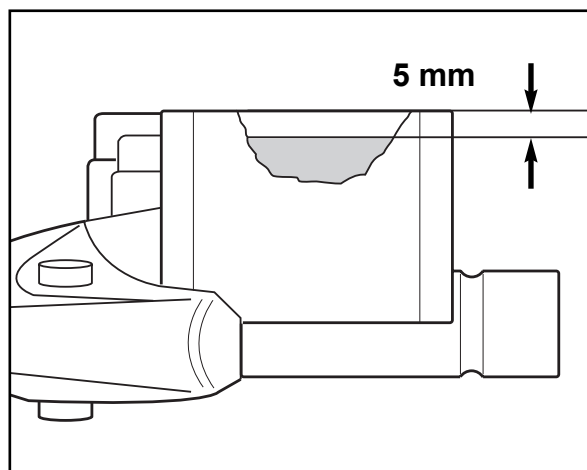

CHECKING THE FRONT BRAKE PADS

The brake pads can be seen from the bottom (FS from the rear). The lining thickness should not be less than 1 mm.

 **WARNING:** At their most worn point brake pad linings should not be thinner than 1 mm, otherwise they could lead to brake failure. For your own safety don't put off having your brake pads changed.

 **CAUTION:** If the brake pads are replaced too late so that the lining is partly or entirely worn, the steel components of the brake pad will rub against the brake disc, thereby impairing the braking effect and destroying the brake disc.

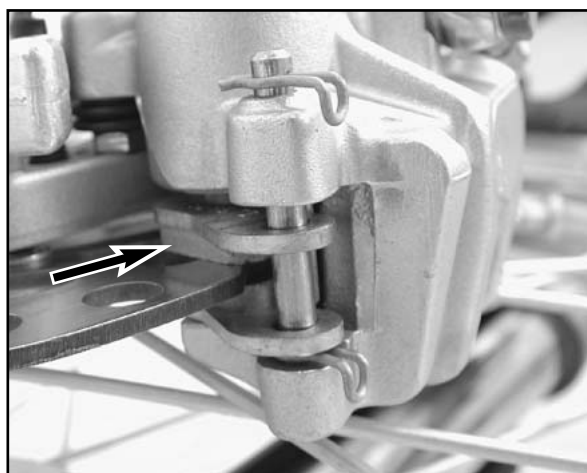

REPLACING THE FRONT BRAKE PADS (FE) *

Press the brake caliper toward the brake disk, to put the brake piston in its basic position. Remove clips (1) and pull out bolt (2). Remove brake pads from the brake caliper. Clean the brake caliper and the brake caliper support with compressed air. Check the sleeves of the guide bolts for damage, and grease guide bolts if necessary.

Mount the right brake pad and fix it with the bolt. Mount the left brake pad and insert the bolt until it stops. Mount the clips.

When mounting the brake pads, be sure to check for correct fit of the sliding metal-sheet in the caliper support and of the leaf spring.

 **WARNING:** It is very important to keep the brake disk free from oil and fatty matters. Otherwise, the braking effect would be strongly reduced.

After assembly, check if circlips have been fitted correctly.

After working on the braking system, always actuate the hand brake lever or foot brake lever, respectively to ensure that the brake pads will lie against the brake disk and the pressure point is established.

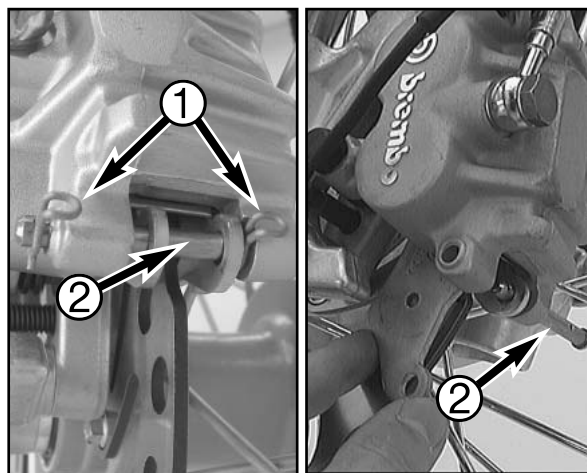

REPLACING THE FRONT BRAKE PADS (FS) *

Remove the screw (3). Carefully press against the brake pads with a screwdriver to move the brake pistons in their basic position. Remove the brake pads from the brake caliper and clean the brake caliper thoroughly with compressed air. Mount the brake pads, mount the screw (3) and hold in place with the securing clip.

 **WARNING:** It is very important to keep the brake disk free from oil and fatty matters. Otherwise, the braking effect would be strongly reduced.

After working on the braking system, always actuate the hand brake lever or foot brake lever, respectively to ensure that the brake pads will lie against the brake disk and the pressure point is established.

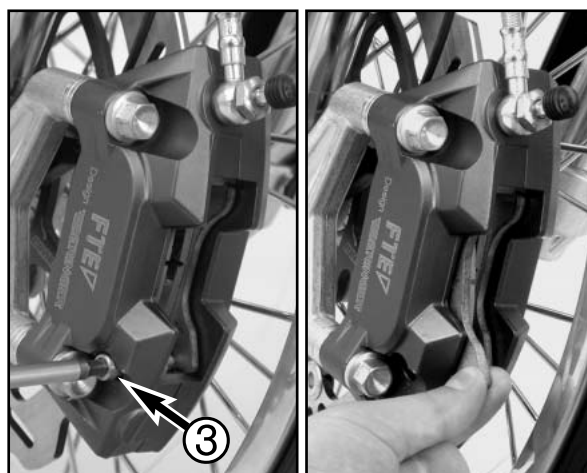

MAINTENANCE WORK ON CHASSIS AND ENGINE

CHANGING THE BASIC POSITION OF THE FOOT BRAKE PEDAL * BRAKE PEDAL *

The basic position of the foot brake pedal can be altered by turning the stop screw (1). The free play at the foot brake pedal must then be adjusted by means of the piston rod (2).

Measured on the outside, the foot brake pedal must have 3-5 mm (0.12–0.20 in) of free play before the piston rod can move the piston in the brake cylinder (to be recognised from the resistance on the foot brake pedal).

 **CAUTION:** If this free play is not present, then pressure can build up in the brake system when driving, causing the rear wheel to brake. The braking system overheats and may even fail completely in extreme cases.

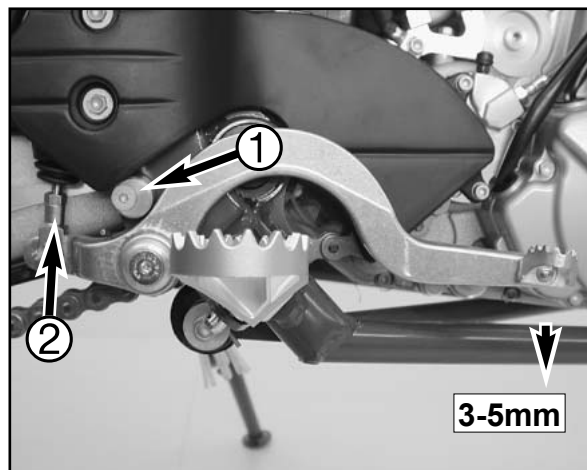

CHECK THE REAR BRAKE FLUID LEVEL

The reservoir for the rear disc brake is located above the main brake cylinder. The level of brake fluid may not fall below the „MIN“ mark when the vehicle has been left standing upright.

 **WARNING:** If the brake fluid level drops below the minimum either the brake system has a leak or the brake pads are completely worn. In this case, consult an authorized Husaberg dealer immediately.

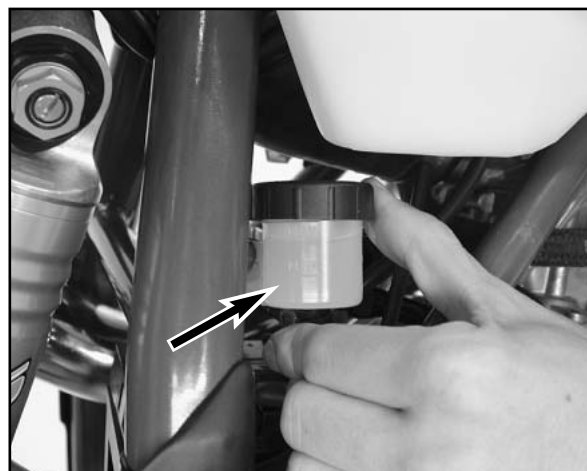

REFILLING THE REAR BRAKE FLUID RESERVOIR *

When the brake fluid level has dropped to the MIN mark, you need to refill the brake fluid reservoir.

For easier access to the brake fluid reservoir it is recommended to remove the hexagon screw. Then move the container outwards as indicated in the illustration. Remove plug (3) with rubber boot (4) and add brake fluid DOT 5.1 (Motorex Brake Fluid DOT 5.1) up to the „MAX“ mark. Replace rubber boot and plug. Overflow or spilled brake liquid must be rinsed off with water. Mount the screw and fix the brake fluid reservoir to the frame, always making sure to prevent kinks in the connecting hose.

 **WARNING:** Never use DOT5 brake fluid! It is based on silicone oil and of a purple color. Seals and brake hoses must be especially adapted to it.

Store brake fluid out of reach of children.

Brake fluid can cause skin irritation. Avoid contact with skin and eyes. If you get brake fluid in your eyes, rinse with plenty of water and consult a doctor.

 **CAUTION:** Don't let brake fluid get in contact with paint, it is an effective paint remover.

Use only clean brake fluid (not older than six months) taken from a tightly sealed container!

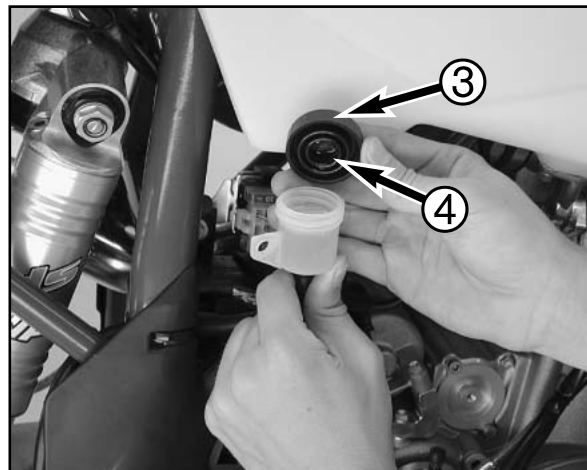

MAINTENANCE WORK ON CHASSIS AND ENGINE

CHECKING THE REAR BRAKE PADS

The brake pads can be inspected from the rear. The thickness of the linings may not be less than 1 mm (0.04 in).

 **WARNING:** At their most worn point brake pad linings should not be thinner than 1 mm, otherwise they could lead to brake failure. For your own safety don't put off having your brake pads changed.

 **CAUTION:** If the brake pads are replaced too late so that the lining is partly or entirely worn, the steel components of the brake pad will rub against the brake disc, thereby impairing the braking effect and destroying the brake disc.

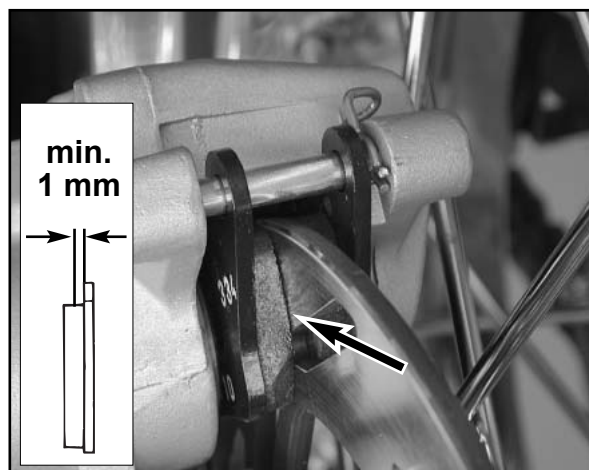

REPLACING THE REAR BRAKE PADS *

Push the brake caliper (1) toward the chain wheel in order to move the brake piston into its basic position. Remove the clip (2), pull out the bolt (3), and remove the brake pads. Thoroughly clean the brake caliper with compressed air and check the sleeves of the guide bolts for damage.

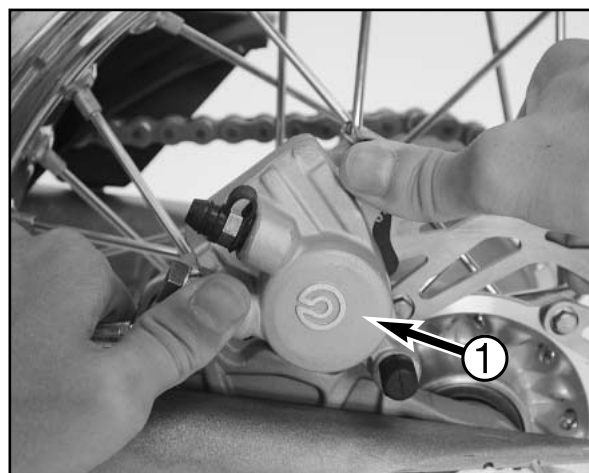

Insert the left brake pad into the brake caliper and secure it with the bolt. Insert the right brake pad and push the bolt (3) into the brake caliper up to the stop. Reattach clip (2).

 **WARNING:** It is very important to keep the brake disk free from oil and fatty matters. Otherwise, the braking effect would be strongly reduced.

After assembly, check if the clip has been fitted correctly.

After working on the braking system, always actuate the hand brake lever or foot brake lever, respectively to ensure that the brake pads will lie against the brake disc and the pressure point is established.

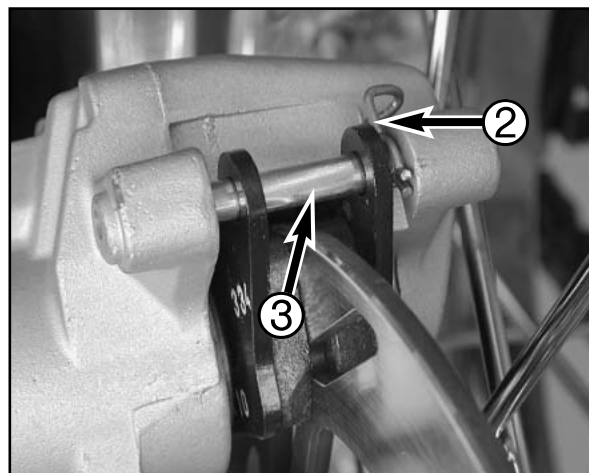

MAINTENANCE WORK ON CHASSIS AND ENGINE

DISMOUNTING AND MOUNTING THE FRONT WHEEL

To remove the front wheel, jack the motorcycle up on its frame so that the front wheel no longer touches the ground. Loosen the 2 clamping screws (1) on the left side of the fork fists. Loosen and remove the collar nut (2), loosen the clamping screws (3) on the right side of the fork fist. Hold the front wheel, pull out the wheel spindle (4).

 **CAUTION:** Do not operate the hand brake when the front wheel has been dismantled.

Make sure the brake disc is always on top when you lay down the wheel, otherwise the brake disc can be damaged.

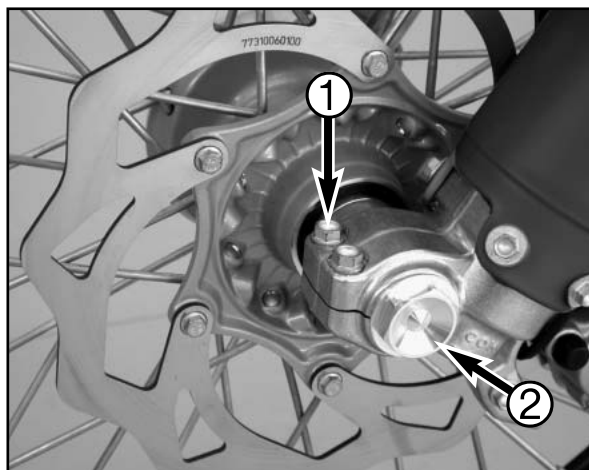

Before remounting the front wheel, clean and grease the shaft seal rings (A) and the bearing surface (B) of the distance bushings and mount the distance bushings

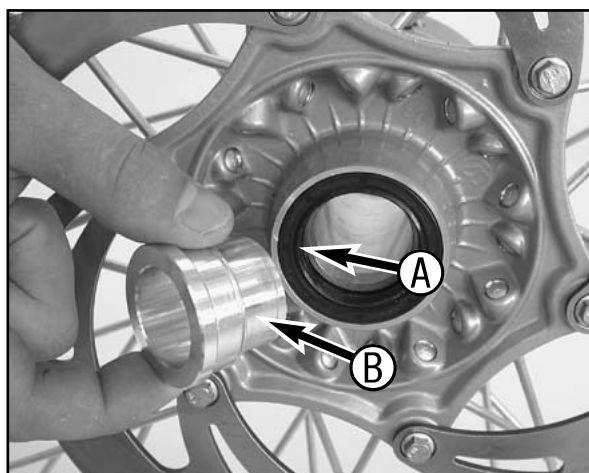

To install the front wheel, lift it into the fork, position and mount the axle shaft (4). Mount the collar nut (2), tighten the clamping screws (3) on the right fork leg axle passage to prevent the axle shaft from turning and tighten the collar nut to 40 Nm.

Loosen the clamp screws on the right fork leg. Take the motorcycle down from its stand. Press the front wheel brakes and push down on the fork a few times vigorously so that the fork legs come into alignment.

Only after this has been accomplished, tighten the clamp screws on both fork legs with 15 Nm.

 **WARNING:** If you don't happen to have a torque wrench at hand, make sure you have the tightening torque corrected by a Husaberg dealer as soon as possible. A loose axle may lead to an unstable driving behavior of your motorcycle.

After mounting the front wheel, keep operating the hand brake until the pressure point returns.

It is very important to keep the brake disc free from oil and fatty matters, otherwise the braking effect would be strongly reduced.



MAINTENANCE WORK ON CHASSIS AND ENGINE

DISMOUNTING AND MOUNTING THE REAR WHEEL

Jack the motorcycle up on its frame so that the rear wheel no longer touches the ground.

Loosen the collar nut (1), remove chain tensioner (2), hold the rear wheel and pull out the wheel spindle (3) until the rear wheel is free but the brake caliper support is still held.

Push the rear wheel as far forward as possible, take the chain from the chain wheel and carefully take the rear wheel out of the swingarm.

 **CAUTION:** Do not operate the rear brake when the rear wheel has been dismantled.

Make sure the brake disc is always on top when you lay down the wheel, otherwise the brake disc can be damaged.

If the axle is dismantled, clean the thread of the wheel spindle and collar nut thoroughly and apply a new coat of grease to prevent the thread from jamming.

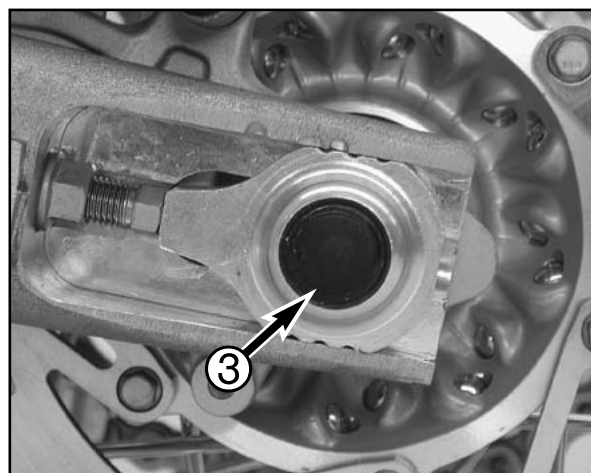
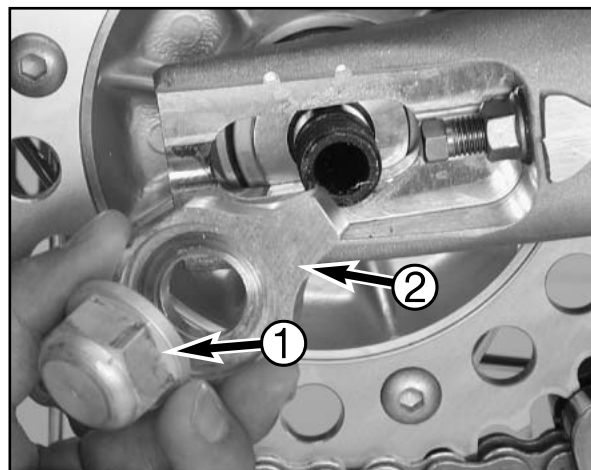

The rear wheel is remounted in the reverse order. Before tightening the collar nut to 80 Nm, push the rear wheel forwards so that the chain tensioners lie on the tension screws.

 **WARNING:** If you don't happen to have a torque wrench at hand, make sure you have the tightening torque corrected by a Husaberg dealer as soon as possible. A loose axle may lead to an unstable driving behavior of your motorcycle.

After mounting the rear wheel, keep operating the rear brake until the pressure point returns.

It is very important to keep the brake disc free from oil and fatty matters, otherwise the braking effects would be strongly reduced.

Tighten the collar nut with the required torque. A loose wheel spindle may lead to an unstable behavior of your motorcycle.

MAINTENANCE WORK ON CHASSIS AND ENGINE

CHECKING THE SHOCK ABSORPTION RUBBERS IN THE REAR HUB*

The FS models have a damped rear wheel hub. For this purpose, the engine power is conveyed from the rear sprocket via 6 shock absorption rubbers (1) to the rear wheel. These 6 absorption rubbers wear with increasing operation time, and should be checked for wear whenever the rear wheel is dismantled.

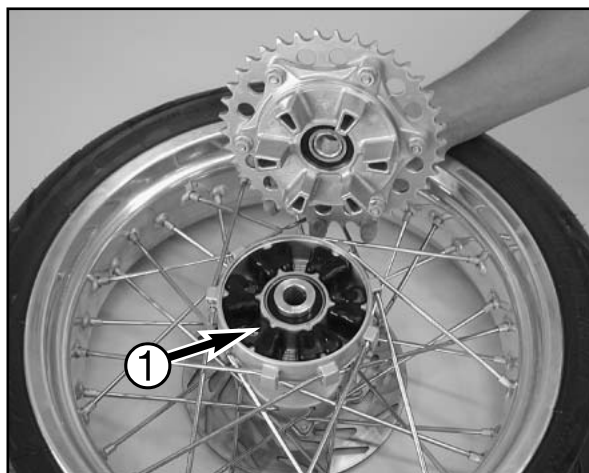

For this purpose, lie the rear wheel on a work bench with the rear sprocket upwards, and put the wheel spindle in the hub. Now hold the rear wheel firmly and try to turn the rear sprocket. The rear sprocket may not turn more than maximum 5 mm (0,2 in) measured on the outside. If the play in the chain wheel is larger, all 6 shock absorption rubbers are to be replaced.

Check the shock absorption rubbers for signs of damage and dirt.

 **CAUTION:** If the shock absorption rubbers are not replaced in good time, the rear sprocket carrier and the rear hub will be damaged. Always replace all 6 absorption rubbers, never single rubbers.

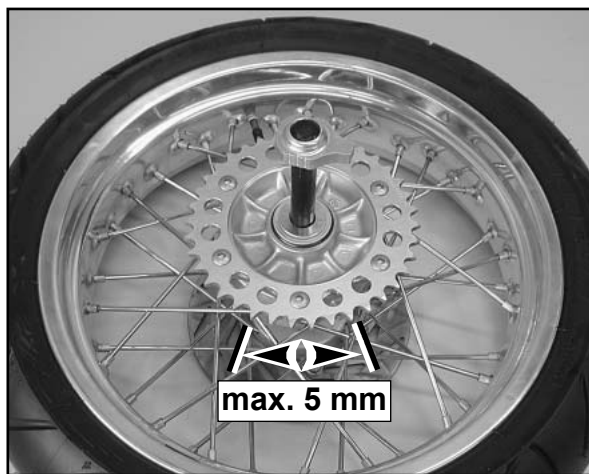

CHECKING SPOKE TENSION

The correct spoke tension is very important for the stability of the wheels and thus for riding safety. A loose spoke causes the wheel to become unbalanced and before long other spokes will have come loose. Check spoke tension, especially on a new motorcycle, at regular intervals. For checking, tap on each spoke with the blade of a screwdriver (see photo). A clear tone must be the result. Dull tones are indicators of loose spokes. If necessary, have the spokes retightened and the wheel centered by a Husaberg dealer.

 **WARNING:** Spokes can tear if you continue to ride with them loose. This may lead to an unstable handling of your motorcycle.

Excessively tensioned spokes may rupture due to local overloading. The spokes must be tensioned to 5 Nm



MAINTENANCE WORK ON CHASSIS AND ENGINE

TIRES, AIR PRESSURE

Tire type, tire condition, and air pressure level affect the way your motorcycle rides and must therefore be checked whenever you are getting ready to go anywhere on your motorcycle.

- Tire size can be found in the technical specifications and in the homologation certificate
- Tire condition has to be checked every time you want to ride your motorcycle. Before leaving, check tires for punctures and nails or other sharp objects that might have become embedded in them.
- Refer to the specific regulations in your country for minimum tire tread requirements. We recommend you replace the tires at the latest when the tread is down to 2 mm (0.08 in).
- Tire pressure should be checked regularly on a "cold" tire. Proper pressure ensures optimum driving comfort and extends the life of your tires.



WARNING: Do not mount tires which have not been approved by Husaberg. Other tires could have adverse effects on the way your motorcycle behaves.

Front and rear wheels may only be fitted with tires having the same tread layout. Use homologated tires.

For your own safety replace damaged tires immediately.

Worn tires can have a negative effect on how your motorcycle performs, especially on wet surfaces.

If air pressure is too low, abnormal wear and overheating of the tire can result.



TIRES-AIR PRESSURE

	front	rear
Offroad FE	1,0 bar	1,0 bar
Road FE	1,5 bar	2,0 bar
Road FS	1,5 bar	2,0 bar

CHECK/SET DISTANCE OF THE MAGNETIC SENSOR

The distance between magnet (2) and sensor (1) must be 2-4 mm (0,08-0,16 in), otherwise malfunctions on the speedometer might occur.

This distance can be corrected by screwing in or off the sensor (1).

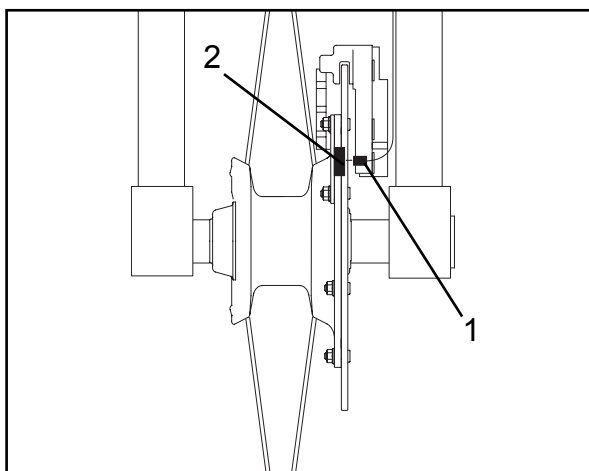
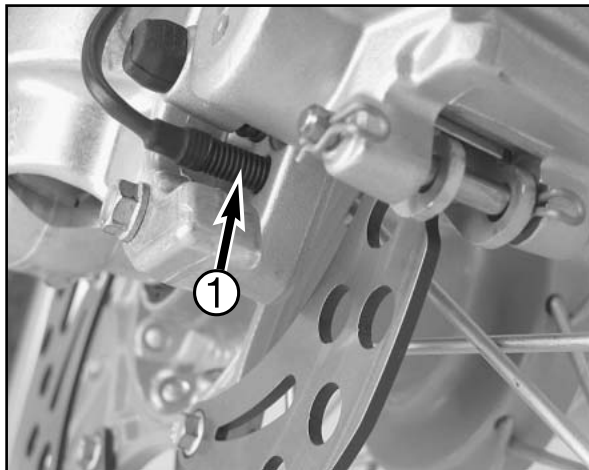

MAINTENANCE WORK ON CHASSIS AND ENGINE

BATTERY

The battery (1) is located in front of the shock absorber and is maintenance-free.

It is not necessary to check the electrolyte level or to add water. Merely keep the battery poles clean and grease slightly with acid-free grease if required.

 **WARNING:** If electrolyte (sulphuric acid) leaks from the battery, proceed with great care. The electrolyte can cause severe burns.

In the case of skin contact rinse thoroughly with water.

In the case of contact with the eyes, thoroughly rinse eyes with water for at least 15 minutes. Immediately consult a doctor.

The battery is a closed model but can nevertheless emit explosive gases. Avoid sparks and open fire near the battery.

Defective batteries must be stored out of the reach of children. Ensure proper disposal of discarded batteries.

 **CAUTION:** To avoid damage, do not remove the locking bar (2)!

Never disconnect the battery while the engine is running. This will destroy the rectifier-regulator.

BATTERY STORAGE:

When preparing the motorcycle for a longer period of standstill, remove the battery and recharge it. Storage temperature: 0 - 35°C (30 - 95°F). Do not expose to direct sunlight.

Charge the battery every 3 months.

CHARGING THE BATTERY

The battery discharges every day, even if it is not used.

Always disconnect the battery when charging. Charge the battery as described in the instructions (3) on the battery housing. Do not exceed the amperage and charging time. Quick charging at a high amperage has an adverse effect on the service life.

Always use special charging devices to charge maintenance-free batteries, e.g. the charging device item no. 58429074000. You can also use this charging device to test the off-load voltage and startability of the battery and generator. It is impossible to overcharge the battery with this device.

Charge the battery immediately if it is empty when you start the motorcycle. If left to stand in an uncharged condition for a longer period of time, the battery will run down and sulfatize, destroying the battery.

Recharge the battery every 3 months if it is being stored for a longer period of time.

 **CAUTION:** Never remove the closure (2) since it will be damaged.

To avoid damage to the on-board electronic system, always disconnect the minus pole before you charge the battery.

To charge, connect the battery to the battery charger before you switch on the battery charger. When the battery is charged, switch off the battery charger before you disconnect the battery.

Provide adequate ventilation when charging the battery in a closed room; the battery emits explosive gases when charging.

Electrolytes will escape through the safety valves if the battery is charged too long or at an excessive voltage or amperage. This will reduce battery capacity.

Try to avoid quick charges.

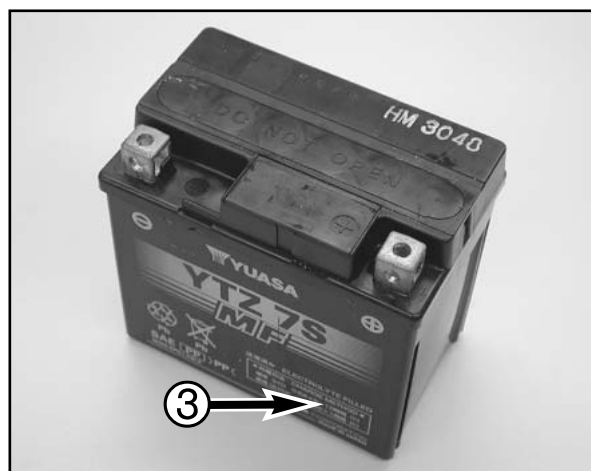
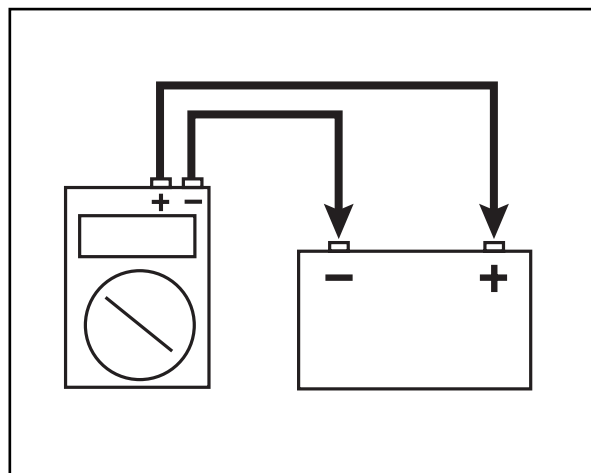
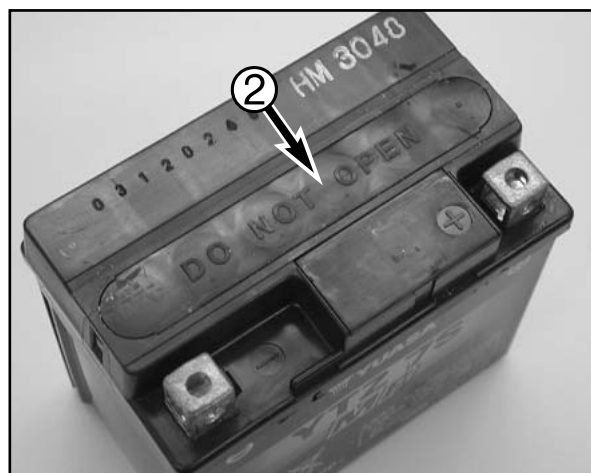
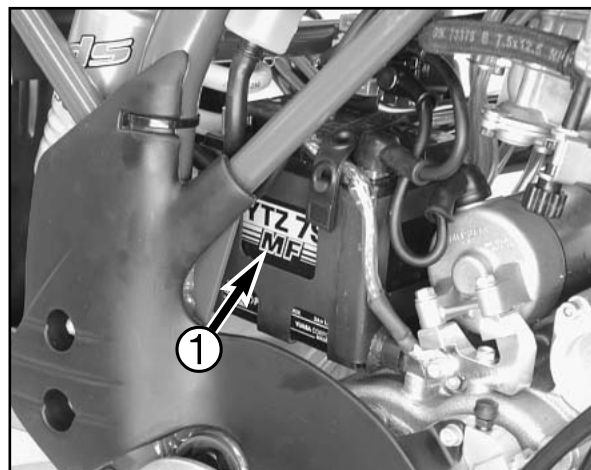

MAINTENANCE WORK ON CHASSIS AND ENGINE

FUSE

The fuse (1) is located in the electric starter relay (2) above the battery. The fuse can be seen after removing the protection cover (A).

The following loads are connected to it:

- E-starter system
- Horn
- Speedometer
- Flasher light

The starter relay also contains a (10 amp) spare fuse (3).

Replace a blown fuse only with an equivalent one. If a new fuse that has just been installed gets blown again, you are strongly advised to have it inspected by a Husaberg dealer.

The fuse capacity is 10 Ampere.



CAUTION: Under no circumstances is a stronger fuse allowed to be installed or a fuse allowed to be "repaired". An improper treatment could damage the whole electrical installation.

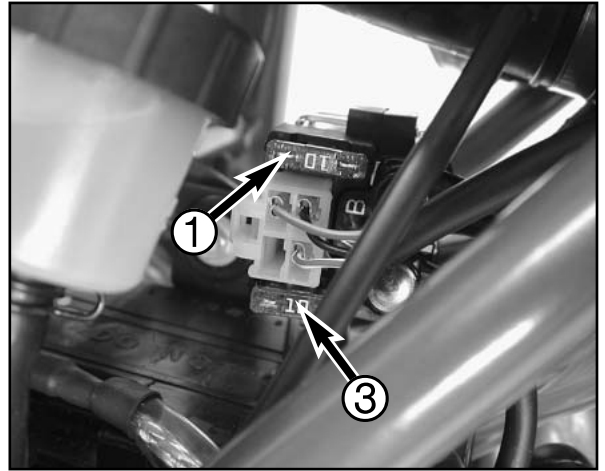
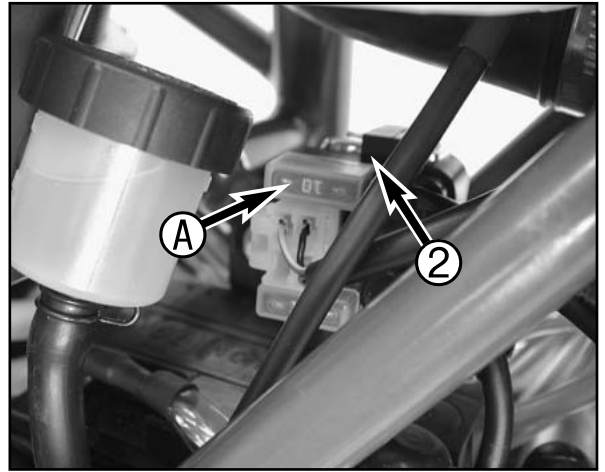

REPLACING HEADLIGHT LAMP/PARKING LIGHT LAMP

Loosen both rubber bands and tilt headlight mask to the front. Pull the parking light lamp with holder (4) carefully out of the reflector. Pull connector (5) off the headlamp and remove rubber cap (6). Disengage retaining clip and take bulb out of reflector. When changing the parking-light lamp, simply pull it out of the holder.

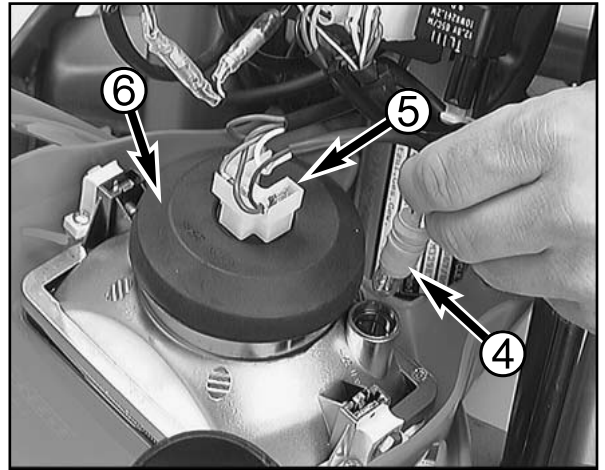

Insert the new lamp such that the noses (7) engage in the recesses (8). When doing so, do not touch the glass body of the lamp so that it remains free from fat. Engage retaining clip, mount rubber cap and connector. If the parking-light lamp is to be replaced, simply insert it in the holder. Reinsert the parking-light lamp together with the holder.

Engage the bottom end of the headlamp mask at the retaining pins and fix the mask by means of the rubber bands.

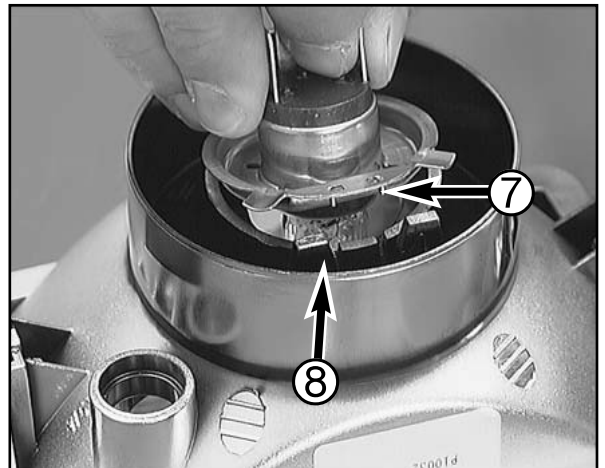

MAINTENANCE WORK ON CHASSIS AND ENGINE

COOLING SYSTEM

Coolant is circulated by a water pump (1) located in the engine. Air blowing in through the radiators cools the coolant. The slower the speed of the motorcycle, the less the coolant is cooled down. Dirty radiators also reduce the cooling efficiency.

Pressure induced by heating of the coolant in the system is controlled by a valve in the radiator cap (2); a water temperature rising up to 120° C (248° F) is admissible, without fear of problems.



WARNING: If possible, always check level of cooling liquid when the engine is cold. If you have to open the radiator cap (2) when the engine is hot, use a rag to cover the cap and open slowly to release pressure. Caution - scalding hazard.

Do not detach any radiator hoses while the engine is hot. The escaping hot coolant and the steam may cause serious burns.

In case you get burnt, hold the affected part of your body under running cold water right away.

Coolant is toxic. Keep the coolant out of the reach of children.

In case coolant is ingested, consult a doctor immediately.

If coolant gets into your eyes, rinse them out with water immediately and consult doctor.

A mixture of 50% antifreeze liquid and 50% distilled water is used as coolant. However, the antifreeze protection must be at least -25° C (-13° F). This mixture offers antifreeze protection but also good corrosion protection and should therefore not be replaced by pure water.



CAUTION: If the coolant has been drained, it will be absolutely necessary to bleed the cooling system during filling.

For the cooling system, use only high-grade antifreeze (e.g. Motorex Anti Freeze). Using lower-grade antifreeze agents can cause corrosion and coolant foaming.

Extreme climate conditions or stop and go Traffic may cause overheating problems.

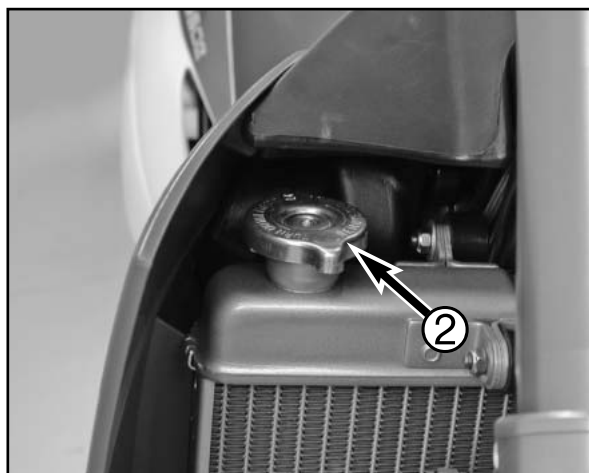
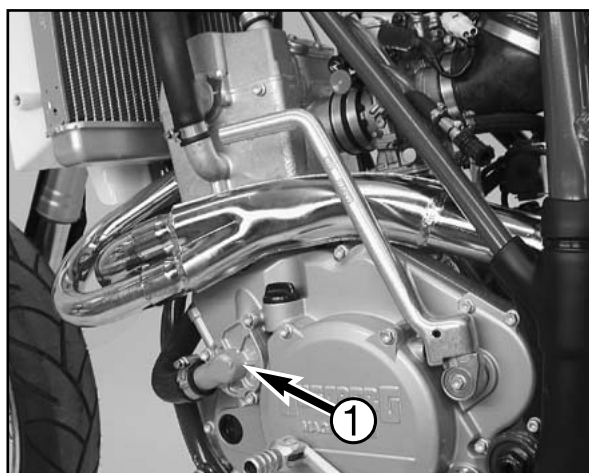

CHECKING THE COOLANT LEVEL

The coolant should be 10 mm (0.4 in) above the radiator fins when the engine is cold (see diagram). In the event of the coolant being drained, always fill and bleed the system.



CAUTION: If the coolant has been drained, it will be absolutely necessary to bleed the cooling system during filling.

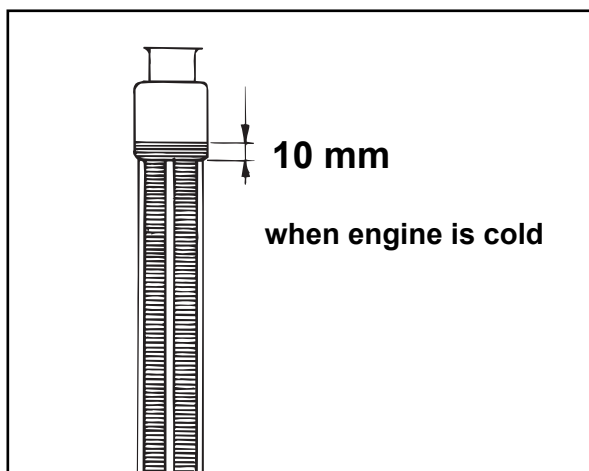

MAINTENANCE WORK ON CHASSIS AND ENGINE

BLEEDING THE COOLING SYSTEM

The cooling liquid is drained by removing the hose (1) from the water pump. To bleed the cooling system, fill in approx. 1 liter (0.26 US gallons) of coolant and remove the bleeder screw (2). Do not reinstall the bleeder screw until coolant escapes at the bore without any bubbles. Then, fill in the coolant until it reaches a level about 10mm above the radiator fins. After a short ride, check the coolant level once more.

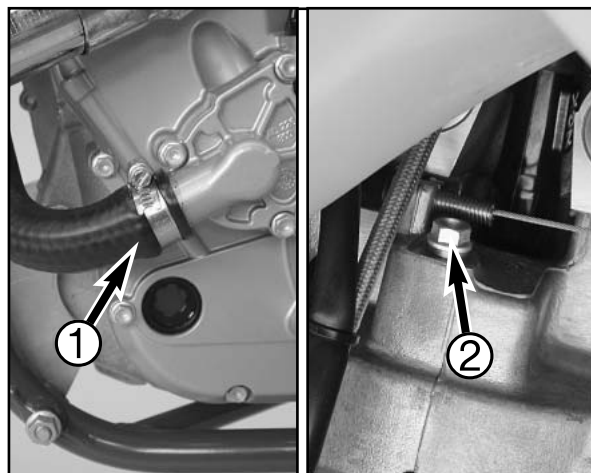

REPLACING THE GLASSFIBER YARN PACKING OF THE SILENCER *

Aluminum silencers are filled with glassfiber yarn to muffle noise. The effect of heat causes the glassfiber yarn to become loose. This may lead to a loss of performance and reduce the silencer's muffling power. By experience, the front glassfiber yarn packing (3) needs to be replaced more often than the rear silencing mat (4).

For this purpose, remove the silencer from the vehicle and dismount the front cap (5). Pull the front glassfiber yarn packing together with the inner exhaust pipe (6) out of the silencer. Clean the front inner exhaust pipe. To facilitate the mounting procedure, you can make a mounting tool (7) out of wood, plastic, or metal. Insert the mounting tool into the inner pipe and mount the glassfiber packing. Push the inner pipe containing the packing into the silencer such that the slot engages the web (A). Use a blunt ended object to stuff the glassfiber yarn packing all the way into the silencer, and mount the front cap (C).

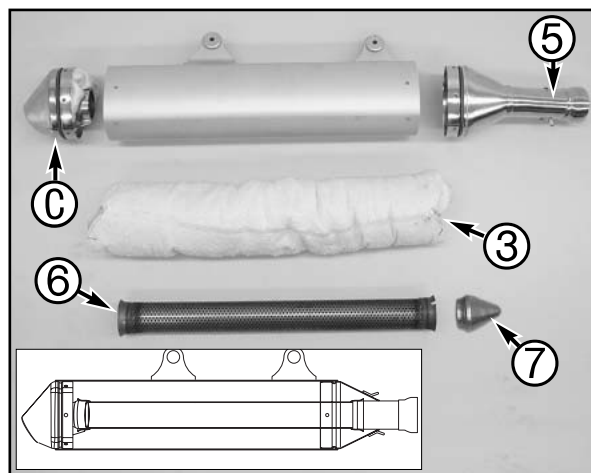

To change the rear silencing mat, start by removing the front packing and the inner exhaust pipe. Then, drill open the rivets and remove the end cap.

 **NOTE:** In every exhaust repair procedure, the O-rings must be replaced by new ones. Glass fiber yarn packings are available from your licensed Husaberg mechanic.

 **WARNING:** The exhaust system becomes very hot while the motorcycle is running. To avoid burns do not start work on the exhaust system until it has properly cooled down.

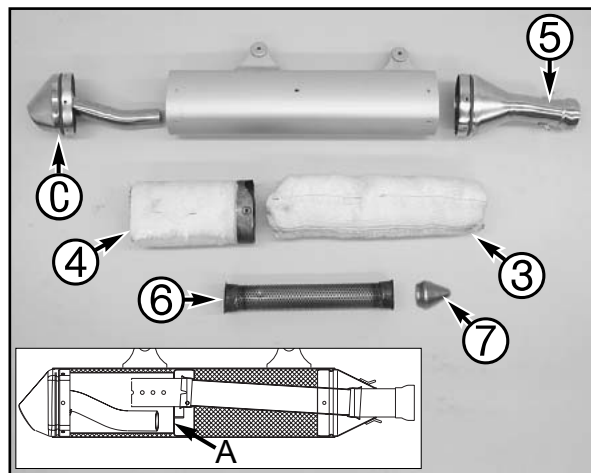

CLEANING THE SPARK ARRESTER *

The spark arrester should be cleaned every time the glassfiber yarn filling is changed or at least once annually.

For this purpose, dismount the silencer cap and remove any deposits that might exist in region (B). Renew the O-ring and mount the silencer cap.

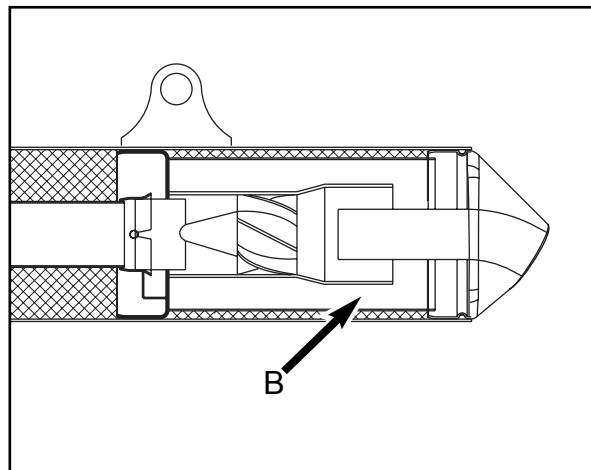

MAINTENANCE WORK ON CHASSIS AND ENGINE

CLEANING THE AIR FILTER *

The air filter must be cleaned prior to every race or depending on the accumulation of dust.

To clean, remove the seat, unscrew the wing screw and remove the air filter together with the filter support.

 **CAUTION: Do not clean air filter with fuel or petroleum since these damage the foam. Husaberg recommends the products of the company „Motorex“ for air filter maintenance. (Motorex Bio Dirt Remover + Motorex Liquid Bio Power)**

Never operate your motorcycle without air filter. Otherwise, dust and dirt may get into the engine and lead to increased wear.

Thoroughly wash the air filter with special cleaning fluid and allow to dry. Press out the water from the air filter but do not wring. Lubricate the dry air filter with high-grade filter oil. Check the carburetor connection boot for damage and a good fit.

Mount the air filter on the filter support. Attach the air filter and filter support to the frame, making sure it is centered and fix with the wing screw.

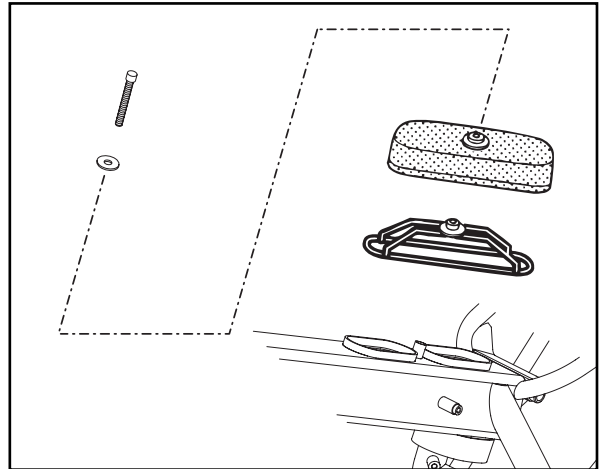

CHECKING THE ADJUSTMENT OF THE HAND DECOMPRESSION RELEASE CABLE *

Start the engine and, at idling speed, slowly pull the hand decompression lever until you can feel the thumping of the rocker arm on the lever. The backlash until said thumping should be approx. 10mm, measured at the lever's outer end. If necessary, correct this backlash.

To adjust, move back the protective cover (1), loosen the counter nut (2) and correct the adjustment screw (3) accordingly. Tighten counter nut and push back protective cover.

 **CAUTION: The setting of the decompression cable should be checked regularly. If there is no play in the deko-lever, this can result in engine damage.**

 **NOTE: No adjustment need be made to the automatic decompressor.**

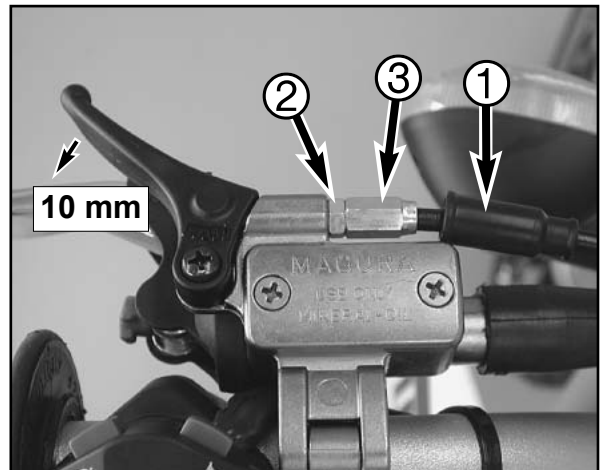

ADJUSTING THE THROTTLE CABLES *

The throttle grip should always provide for a backlash of 3-5 mm. Besides, with the engine running, the idling speed must not change if you turn the handlebar all the way to the left or right.

To adjust the throttle cables, dismount the seat and the tank together with spoilers. Slide back the protection cover (4). Loosen the counternut (5) and turn the adjusting screw bk accordingly. Turning the adjusting screw (6) counterclockwise will reduce the backlash, turning the adjusting screw clockwise will increase the backlash.

Tighten the counternut and check whether the throttle grip can be actuated smoothly. Mount tank and seat.

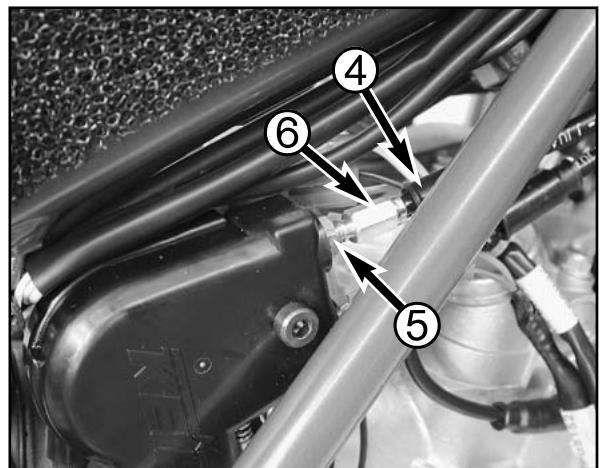

MAINTENANCE WORK ON CHASSIS AND ENGINE

CHANGING THE ORIGINAL POSITION OF THE CLUTCH LEVER

The adjusting screw (1) can be used for individual adjustment of the original position of the clutch lever, thus allowing adjustment to an optimal position for every hand size.

Turning the adjusting screw counterclockwise reduces the distance between the clutch lever and the handlebar. Turning the adjusting screw clockwise increases the distance between the clutch lever and the handlebar.

CAUTION: Adjustment of the clutch lever position is only possible within certain limits. Only turn the adjusting screw manually and never apply excessive force.

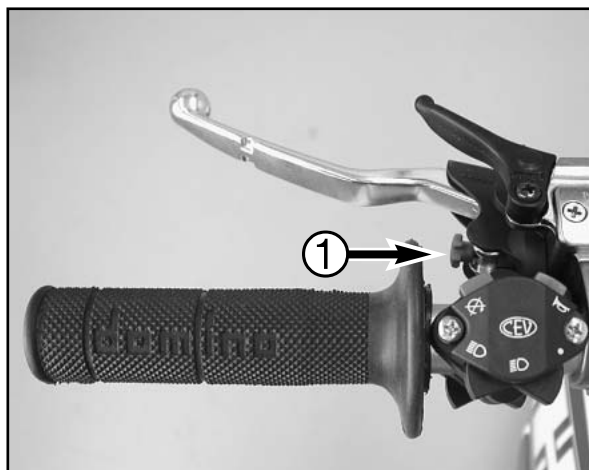

CHECKING THE OIL LEVEL OF THE HYDRAULIC CLUTCH

To check the oil level in the master cylinder of the clutch remove the cover. For this purpose, remove screws (2) and cover (3) together with the rubber boot (4). The oil level in the horizontal-standing master cylinder should be 4 mm below the upper edge.

If necessary, fill up with biodegradable hydraulic oil SAE 10 (e.g. Motorex Kupplungs-Fluid 75). Biodegradable hydraulic oil is available from your Husaberg dealer (50ml).

CAUTION: Husaberg uses biodegradable hydraulic oil for the hydraulic clutch control. Never mix biodegradable hydraulic oils with mineral oils. Never refill with mineral hydraulic oil or brake fluid.

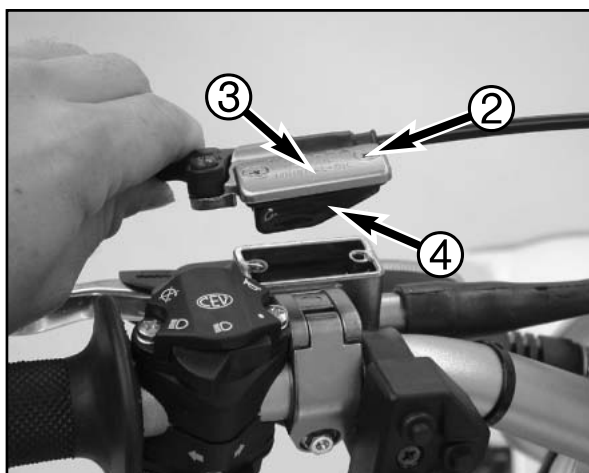

BLEEDING OF THE HYDRAULIC CLUTCH *

To bleed, the cover of the master cylinder of the clutch needs to be removed. For this purpose, remove screws (2) and take off cover (3) together with rubber bellows (4). At the slave cylinder of the clutch, remove the bleeder nipple (5). In its place, mount the bleeder syringe (6) which is filled with SAE 10 hydraulic oil. Refill oil until oil is discharged from the bore (7) of the master cylinder in a bubble-free state. Make sure that the oil does not overflow. The bleeder syringe can be purchased from your Husaberg dealer. Having completed the bleeding procedure, you have to verify that the oil level in the master cylinder is correct. If necessary, fill up with biodegradable hydraulic oil SAE 10 (e.g. Motorex Kupplungs-Fluid 75). Biodegradable hydraulic oil is available from your Husaberg dealer (50ml).

CAUTION: Husaberg uses biodegradable hydraulic oil for the hydraulic clutch control. Never mix biodegradable hydraulic oils with mineral oils. Never refill with mineral hydraulic oil or brake fluid.

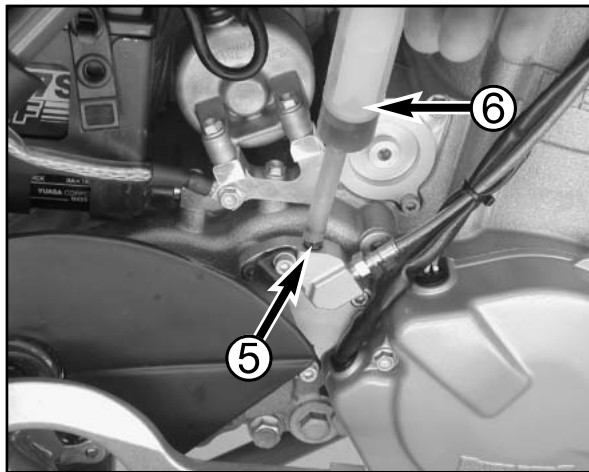

MAINTENANCE WORK ON CHASSIS AND ENGINE

CARBURETOR – ADJUST IDLING *

Idling adjustment of the carburetor strongly affects the engine's starting behavior. That is, an engine whose idling speed is adjusted correctly will be easier to start than one whose idling speed has not been adjusted correctly.

The idle speed is controlled by means of the adjusting wheel (1) and the mixture control screw (2). The adjusting wheel is used to adjust the basic setting of the slide. The mixture control screw is used to control the idle mixture which arrives at the engine by way of the idle system. Clockwise turning reduces the fuel quantity (lean mixture), counterclockwise turning increases the fuel quantity (rich mixture).

To adjust idling correctly, proceed as follows:

- 1 Turn in mixture control screw (2) up to the stop, and turn it back out to the basic position (see technical date-engine)
- 2 Warm up the engine
- 3 Use the adjusting wheel (1) to set the normal idle speed (1400 - 1500 rpm).
- 4 Turn mixture control screw (2) slowly clockwise until idling speed starts to decrease. Memorize this position, and turn mixture control screw slowly counterclockwise until the idling speed decreases again. Adjust the point of the highest idling speed between these two positions. If, in the course of this procedure, the speed undergoes a relatively high increase, reduce the idle speed to a normal level and repeat the procedure specified in 4. Serious competitive racers will choose a setting approx. 1/4 turn (clockwise) leaner than this ideal value because their engine will heat up more when used in competitions.



NOTE: If you fail to obtain a satisfying result by following the procedure described above, an incorrectly dimensioned idling nozzle may be the cause. If:

a) the mixture control screw has been screwed in up to the stop without causing any change in rotational speed, a smaller idling jet has to be installed;

b) the engine dies when the mixture control screw is still open by 2 turns, a larger idling jet needs to be selected.

Naturally, in cases of jet changes, you have to start your adjusting work from the beginning.

- 5 Then, use the adjusting wheel to set the desired idle speed.
- 6 In cases of greater changes in the outside temperature and extremely different altitudes, the idling speed should be readjusted.

BASIC INFORMATION ON CARBURETOR WEAR

As a result of engine vibrations, the throttle valve, jet needle, and needle jet are subjected to increased wear. This wear may cause the carburetor to malfunction (e.g., overly rich mixture). Therefore, these parts should be replaced after 200 hours.

ADJUSTING THE MIXTURE CONTROL SCREW *

The mixture control screw is used to adjust the idle mixture. Turning the mixture control screw in a clockwise direction will reduce the idle mixture, turning it in a counterclockwise direction will increase the idle mixture.

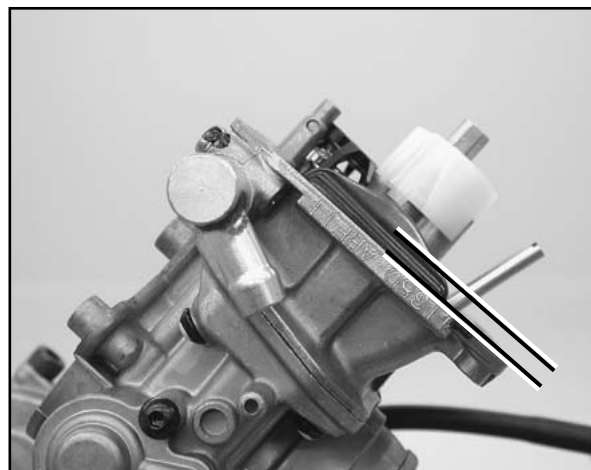
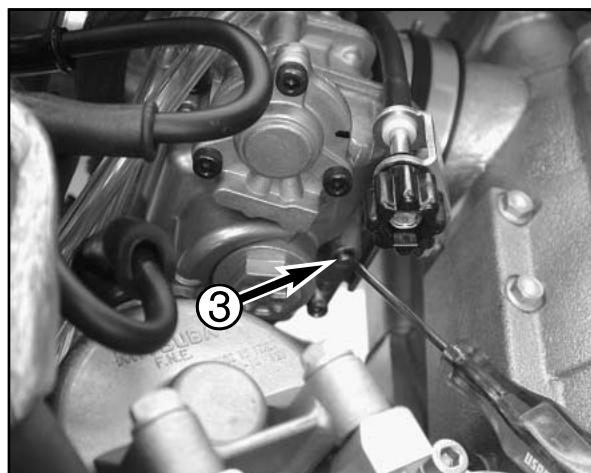
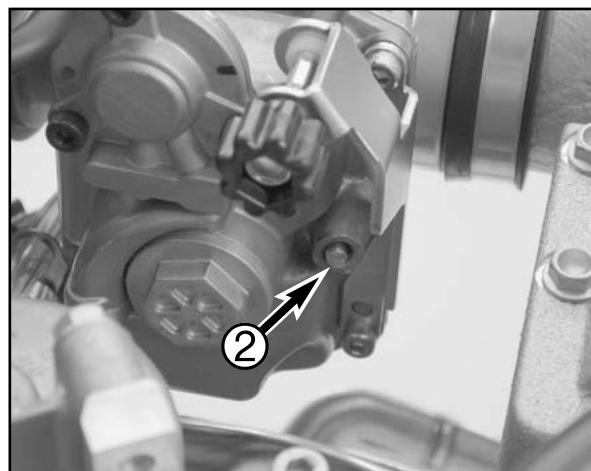
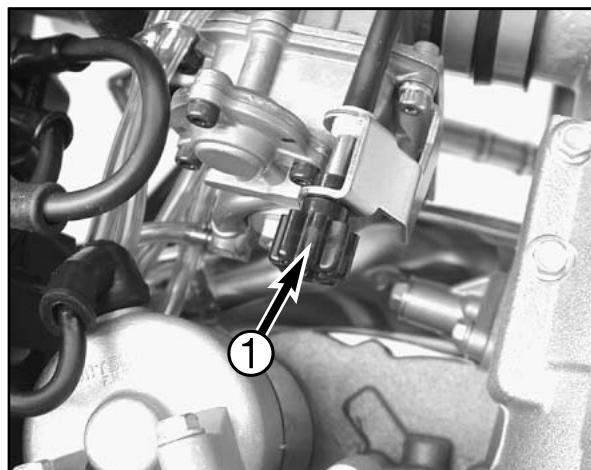

MAINTENANCE WORK ON CHASSIS AND ENGINE

CHECKING THE FLOAT LEVEL (FLOAT HEIGHT) *

For this purpose, dismount the carburetor and remove the float chamber. Hold the carburetor in a slanted position such that the float will abut the float needle valve but not compress it.

In this position, the edge of the float should be parallel with the float chamber sealing surface (see illustration).

If the float height does not correspond to the desired value, check the float needle valve and, if necessary, replace it.

If the float needle valve is o.k., you can adjust the float height by bending the float lever (1).

Mount the float chamber, install the carburetor, and adjust the idle speed.

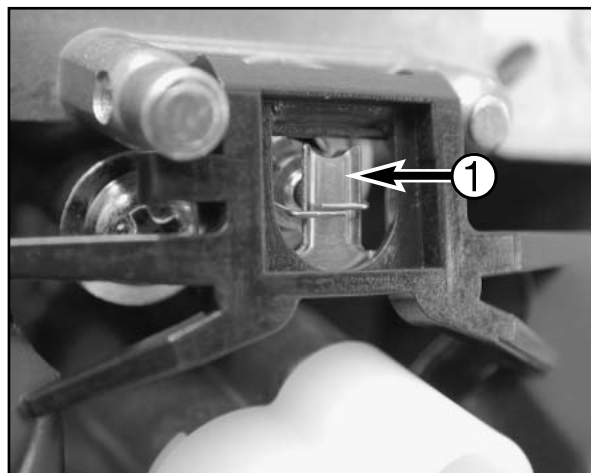

DRAINING THE FLOAT CHAMBER OF THE CARBURETOR *

Following every wet cleaning procedure, the float chamber of the carburetor should be drained in order to remove any water that may have penetrated into it. Water in the float chamber causes engine malfunction.

Perform this task on a cold engine. Close the fuel tap, and place a cloth underneath the carburetor, which is able to absorb any escaping fuel. Unscrew the plug (2), and clean it with compressed air. Mount the plug and gasket and tighten to 4 Nm, open the fuel tap, and check the float chamber for any leaks.



NOTE: Fuel is easily flammable and toxic. When handling fuel, be sure to exercise the utmost caution. Never perform any work on the fuel system near open flames or burning cigarettes.

Always allow the engine to cool off first. Immediately clean up any fuel which may have been spilled. Materials saturated with fuel are also easily flammable. In case you ingested fuel or fuel splashed into your eyes, consult a doctor immediately.

Dispose of the fuel properly.

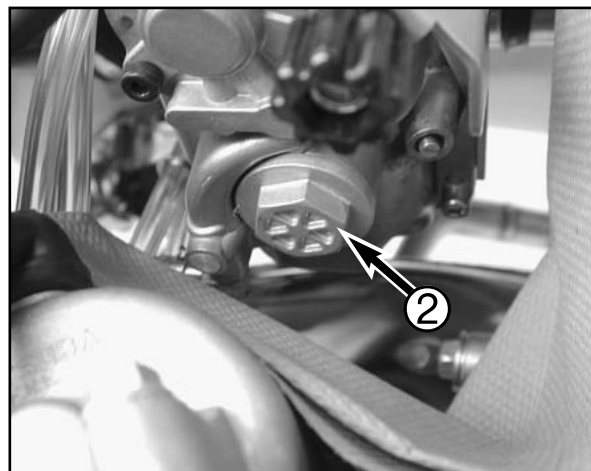

INTERCEPTING TANK FOR THE CARBURETOR VENTILATION:

To prevent fuel from running out after a fall, mount the intercepting tank (included) for racing purposes. Screw the intercepting tank (3) to the bottom of the frame crossrail using the clamp and HH collar screws.

A drain plug is located on the bottom to drain the tank.

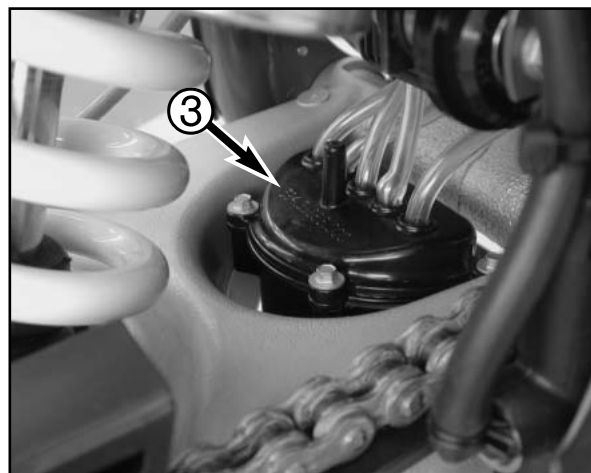

OIL CIRCUIT

The oil pump (4) draws the engine oil from the oil sump through the oil screen (5) and pumps it past the pressure relief valve (6) to the oil filter (7). It continues to the crankshaft (8), partly branching off through a hole to lubricate and cool the piston (9) and the piston pin bearing. Once through the crankshaft, the engine oil is pumped to the conrod bearing (10) and branches off again to the bearings in the balance weight (11).

The camshaft (12) is lubricated by the engine oil which is transported to the cylinder head by the timing chain (13).

On the downward movement of the piston, engine oil is pressed from the crankcase through the diaphragm valve (not depicted) to the transmission and shift mechanism.

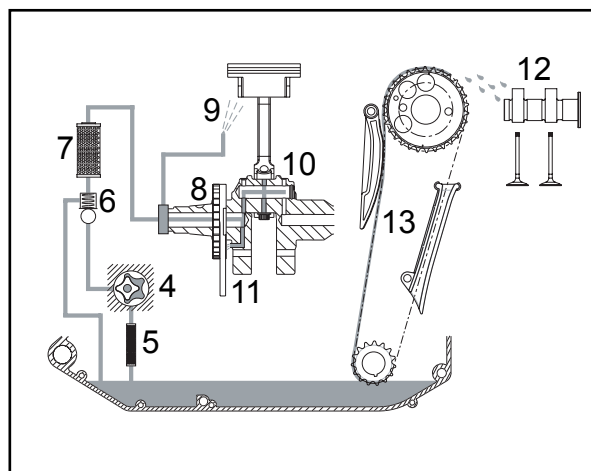

MAINTENANCE WORK ON CHASSIS AND ENGINE

CHECKING THE ENGINE OIL LEVEL

The engine oil level can be checked with the engine either warm or cold. Place the motorcycle in an upright position and on a horizontal surface (not on the side stand).

If the engine is cold, the engine oil must be visible at the lower edge of the inspection glass (A).

If the engine is warm, the engine oil must be visible up to the upper edge of the inspection glass (B).

Replenish the engine oil, if necessary.

 **CAUTION:** Insufficient amounts of or low-grade engine oil lead to premature wear in the engine.

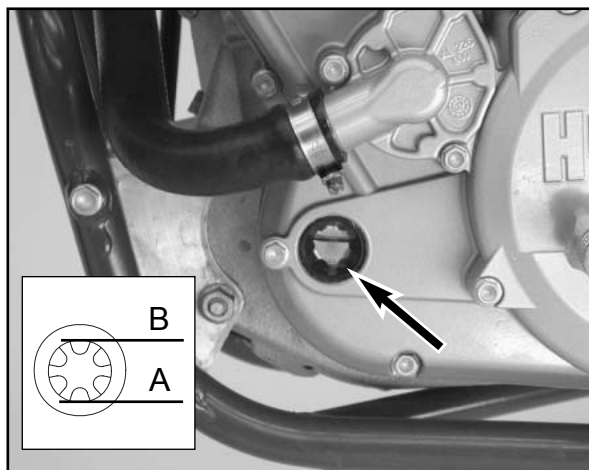

ENGINE OIL

Automobile engine oil used to be used for four-stroke motorcycles before there were separate motorcycle specifications. Different technical developments made it necessary to have a separate specification for four-stroke motorcycles - the JASO T903 MA standard. Whereas car engines require long changing intervals, motorcycle engines require a higher power output at higher speeds. Most motorcycle engines also use the same oil to lubricate the transmission and the clutch. The JASO MA standard responds to these special requirements.

Only use fully synthetic engine oils that meet the JASO MA quality requirements (see information on the can). Husaberg recommends Motorex Power Synt 4T in the 10W/50 viscosity (for temperatures over 0°C, 32°F) or 5W/40 (for temperatures under 0°C, 32°F).

 **CAUTION:** Insufficient amounts of or low-grade engine oil lead to premature wear in the engine.

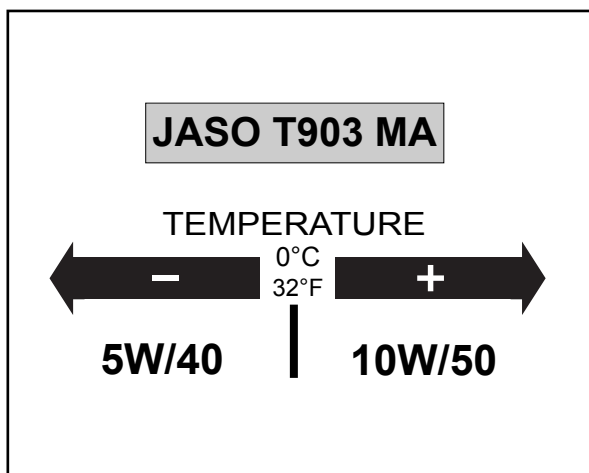

CHANGING THE ENGINE OIL *

 **NOTE:** When changing the engine oil, it is necessary to clean the short and long oil screens and to replace both oil filters.

 **WARNING:** An engine at operating temperature and the engine oil it contains are very hot - do not burn or scald yourself.

Place the motorcycle on a horizontal surface, remove the plug (1) and allow the oil to drain into a receptacle.

Clean plug (with magnet) thoroughly.

Once the entire oil has been drained, clean the sealing surface, mount the plug together with the sealing ring and tighten it to 20 Nm.

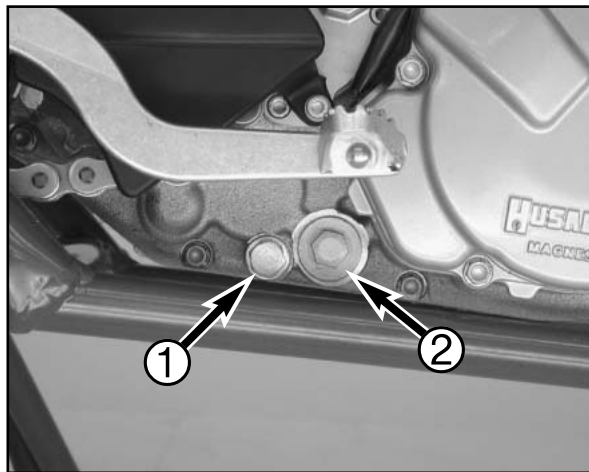

CLEANING THE OIL SCREEN

Dismount the plug (2) with the oil screen, thoroughly clean the parts and blow clean with compressed air.

Check the O-rings (4) for damage and replace if necessary.

Insert the oil screen in the plug (2), mount and tighten the plug to 15 Nm.

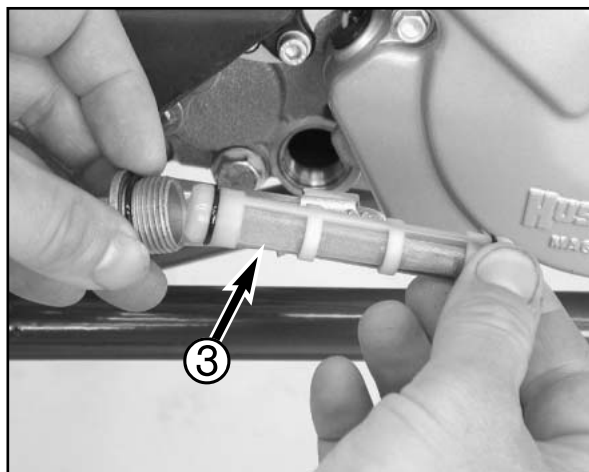

MAINTENANCE WORK ON CHASSIS AND ENGINE

CHANGING THE OIL FILTER

Place a suitable vessel under the engine to allow the oil to drain. Remove both screws (1) and screw an M6 screw in the center hole (2) of the oil filter cover.

 **NOTE: only tighten the screw by hand, otherwise you will damage the oil filter cover.**

Pull the oil filter cover (3) out of the hole with the screw M6 and remove the screw.

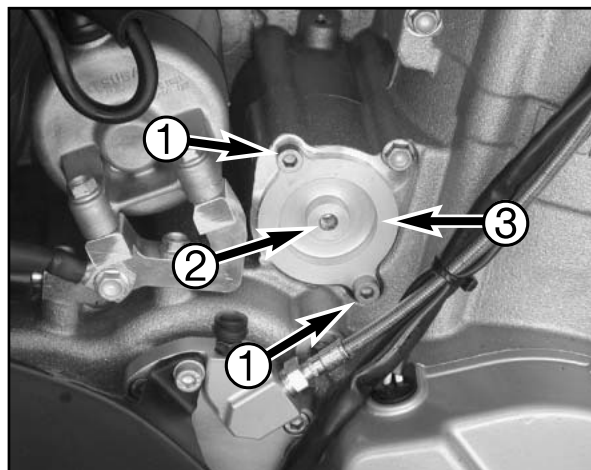

Use pliers to pull the oil filter element (4) from the housing. Clean the oil filter cover, the sealing areas on the O-rings and the engine case. Check the O-rings (5) in the oil filter cover for damage and replace if necessary.

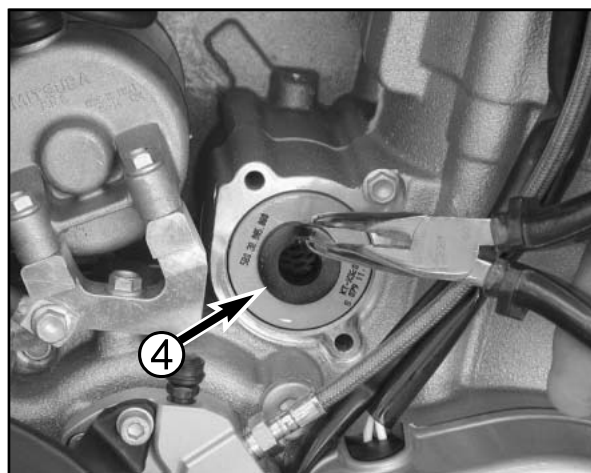

Lay the motorcycle down and fill the oil filter housing approx. half-full with engine oil. Insert the oil filter in the housing. Grease the O-rings in the oil filter cover and mount the cover. Mount the screws and tighten to 6 Nm.

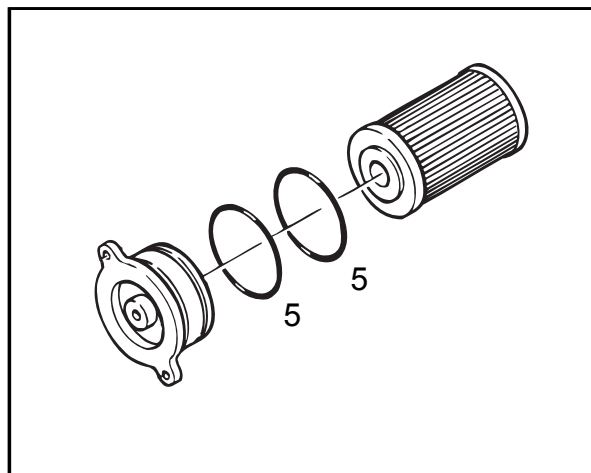

Place the motorcycle in an upright position again.

Unscrew the oil filler plug (6) and add 1 liter of fully synthetic engine oil (e.g.: Motorex Power Synt. 4T).

Start the engine and check all of the plugs and the oil filter cover for leakage.

Finally, check the engine oil level and correct if necessary.

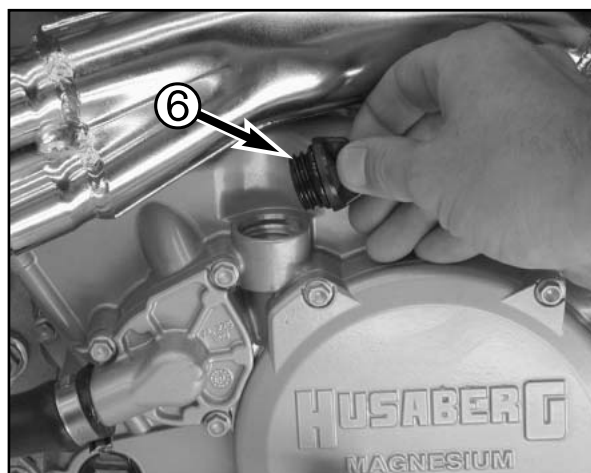

TROUBLESHOOTING

TROUBLE	CAUSE	REMEDY
Engine doesn't crank (E-starter)	<p>Operating error</p> <p>Blown fuse</p> <p>Discharged battery.</p> <p>Low outside temperature</p>	<p>Turn on the emergency-OFF switch (Australia only)</p> <p>Dismount the left paneling and the filter box cover and replace the fuse in the starter relay.</p> <p>Recharge the battery and investigate the causes for discharging; contact a Husaberg dealer.</p> <p>Start the engine with the kickstarter</p>
<p>Engine cranks but doesn't start (E-starter).</p> <p>Engine will not start (Kickstarter)</p>	<p>Operating error</p> <p>The motorcycle has been out of operation for a longer period of time. Therefore old fuel has accumulated in the float chamber</p> <p>Fuel supply interrupted</p> <p>Flooded engine</p> <p>Sooty or wet spark plug</p> <p>Electrode gap too large</p> <p>Spark plug connector or spark plug faulty</p> <p>Short circuit cable scored in wiring harness, emergency OFF switch or short circuit button faulty</p> <p>The plug connection of the CDI-unit, the pulse generator or the ignition coil has oxydized</p> <p>Water in carburetor or jets blocked</p>	<p>Open fuel tap, tank fuel, actuate choke. Pay attention to starting information (see driving instructions).</p> <p>The easily inflammable components of the new fuels evaporate during longer periods of standing still. When the motorcycle has been out of operation for more than a week, it is therefore recommended to drain the old fuel from the float chamber. The engine will immediately start when the float chamber is filled with new fuel.</p> <p>Close fuel tap, loosen fuel hose at carburetor, lead into a basin and open fuel tap</p> <ul style="list-style-type: none"> - if fuel leaks out, the carburetor may need cleaning - if no fuel leaks out, check tank ventilation, i.e. clean fuel tap <p>In order to "pump the engine free", pull the hand decompression lever, fully rev up the engine, actuate the kickstarter 5 to 10 times or actuate the E-starter 2 times for 5 seconds each. Then, start the engine as described above. If the engine fails to start, unscrew the spark plug and dry it.</p> <p>Clean and dry the spark plug or exchange it, respectively</p> <p>Adjust spark plug electrode gap to 0.6 mm</p> <p>Dismount spark plug, connect ignition cable, hold to ground (blank place on engine) and actuate starter, a strong spark must be produced at the spark plug</p> <ul style="list-style-type: none"> - If no spark is created replace the spark plug. - If the new spark plug doesn't produce a spark either, disconnect the spark plug connector from the ignition cable, hold it a distance of approx. 5 mm from ground and start. - If a spark now occurs, replace spark plug cap - If no spark is produced, control ignition system <p>Dismount the fuel tank, disconnect the black/yellow cable from the cable of the emergency-OFF switch and the short-circuit button, respectively, and check the ignition spark. If a spark is generated, look for the problem in the short-circuit circuit.</p> <p>Remove the seat and the fuel tank. Clean the plug connection and treat it with contact spray</p> <p>Dismount and clean the carburetor</p>
Engine fails to idle	<p>Glogged idling jet</p> <p>Incorrect adjustment of adjusting screws on carburetor</p> <p>Defective spark plug</p> <p>Defective ignition system</p>	<p>Disassemble the carburetor and clean the jets</p> <p>Have the carburetor adjusted</p> <p>Replace the spark plug</p> <p>Have the ignition system checked</p>

TROUBLESHOOTING

ERROR	CAUSE	REMEDY
Engine won't rev up	Carburetor overflows because the float needle is soiled or worn	Disassemble the carburetor and check for wear
	Loose carburetor jets	Tighten the jets
	Electronic ignition advance is defective	Have the ignition system checked
Engine does not have enough power	Fuel supply is interrupted or the carburetor soiled	Clean and check the fuel system and carburetor
	Air filter is heavily soiled	Clean or replace the air filter
	Exhaust system is not tight, deformed or there is not enough glass-fiber yarn in the silencer	Check the exhaust system for damage, replace the glass fiber yarn in the main silencer
	Valve clearance is too small	Adjust the valve clearance
	Compression loss due since hand decompression lever is inadequately adjusted	Adjust the hand decompression cable
	Electronic ignition advance is defective	Have the ignition system checked
Engine stops or backfires in the carburetor	Shortage of fuel	Clean and check the fuel system and carburetor
	Engine draws in unmeasured air	Check the rubber sleeve and carburetor for a tight fit
Engine gets too hot	Not enough cooling liquid in the cooling system	Add cooling liquid (see maintenance work), check the cooling system for tightness
	Incorrect carburetor jetting	Check the carburetor jetting and correct if necessary (see Basic Carburetor Setting)
	Not enough air stream	Continue driving speedily
	Cooling system not ventilated	Ventilate the cooling system
	Radiator fins are heavily soiled	Clean the radiator fins with a water jet
	Foam has formed in the cooling system	Replace the cooling liquid, use brand-name antifreeze
	Bent radiator hose	Shorten or replace the radiator hose
High oil consumption	Bent engine ventilation hose	Install the ventilation hose without kinks or replace
	Engine oil level is too high	Check the engine oil level and correct if necessary
	Engine oil is too thin	Use a thicker engine oil, see "Engine oil" chapter (viscosity)
All of the switched on lights are burned out	The voltage regulator is defective	Have the voltage regulator checked
Horn, turn signal and starter do not work	Fuse in the starter relay is blown	Renew the fuse
Battery is dead	Battery is not being charged by the generator	Check the connections on the voltage regulator; have the voltage regulator checked at an authorized workshop

CLEANING, CONSERVATION, STORAGE

CLEANING

Clean your motorcycle regularly in order to maintain the beauty of its plastic surfaces.

The best manner would be to use warm water that has been mixed with a normal brand-name washing detergent and a sponge. The hard dirt can be removed before washing with the help of a soft water jet.



CAUTION: If using a power washer, do not point the water jet at the electric components, plugs, cables, bearings, carburetor, etc. The high pressure will cause water to penetrate into the components and can cause them to malfunction or lead to premature wear.

- You should use normal brand-name detergents to clean the motorcycle. Especially dirty parts should also be cleaned with the help of a paint brush.
- Before cleaning with water, plug the exhaust pipe to prevent water ingress
- After the motorcycle has been rinsed with a soft water jet, it should be dried by air pressure and a cloth. Drain the float chamber of the carburetor. Then take a short drive until the engine has reached the working temperature and also use the brakes. By warming these components, the residual water can evaporate from inaccessible parts of the engine and the brakes.
- Slide back the protective covers on the handlebar-mounted instruments so that any water that may have seeped into this part of the motorcycle is allowed to evaporate.
- Once the motorcycle has cooled down, oil or grease all sliding and bearing points. Treat the chain with a chain spray. Also oil the fuel tap.
- To avoid any failures in of the electric system, you should treat the emergency-OFF switch, short-circuit button, light switch and socket connectors with a contact spray.

CONSERVATION FOR WINTER OPERATION

In the event that the motorcycle is also used in winter and on roads where one has to expect salt spraying, you will have to take precautions against the aggressive road salt.

- clean the motorcycle thoroughly and let it dry after each ride
- treat the engine, carburetor, swing arm, and all other bare or galvanized parts (except for brake discs) with a wax-based anti-corrosion agent.



WARNING: Keep the anti-corrosion agent from getting into contact with the brake discs, otherwise this will significantly reduce the braking power.



CAUTION: After rides on salted roads, clean motorcycle thoroughly with cold water and let it dry well.

STORAGE

Should you wish to make a pause over a longer space of time, please observe the following instructions:

- Clean motorcycle thoroughly (see chapter: CLEANING)
- Change engine oil, short and long oil filters (old engine oil contains aggressive contaminants).
- Check antifreeze and amount of cooling liquid.
- Warm up the engine once again, close the fuel cock and wait until the engine dies. Then open the drain plug of the float chamber to remove the remaining fuel.
- Remove spark plug and fill in approx. 5 ccm of engine oil into the cylinder through the opening. Actuate kick-starter 10 times in order to distribute the oil onto the cylinder walls and mount the spark plug.
- Set piston to compression so that the valves will be closed (slowly operate the kickstarter until you can hear the automatic decompressor click (release))
- Let fuel flow out of tank into an appropriate container.
- Correct tire pressure.
- Lubricate pivot points of the control levers, foot rests, etc. as well as the chain.
- Service the shock absorber linkage
- Disassemble and charge battery (see chapter: BATTERY).
- The storage place should be dry and not subjected to excessive temperature fluctuations.
- Cover the motorcycle with an air permeated tarpaulin or blanket. Do not use airtight materials as a possible humidity might not be able to escape and could cause corrosion.



CAUTION: It would be very bad to let the engine run for a short time during the storage period. The engine would not get warmed up enough and the thus developed steam would condense during the combustion process and cause the valves and exhaust to rust.

USE AFTER A PERIOD OF STORAGE

- Mount the charged battery (regard polarity), set clock.
- Fill up tank with fresh fuel.
- Check motorcycle as before each start (see driving instructions).
- Take a short, careful test ride first.

TECHNICAL DATA - ENGINE

ENGLISH

ENGINE	FE, FS 450e/6
Design	1-cylinder 4-stroke engine with balancer shaft, liquid cooled
Displacement	449.2 cc
Bore/Stroke	100 / 57.2 mm
Ratio	13:1
Carburetor Keihin	FE: FCR-MX 39 FS: FCR-MX 41
Fuel	unleaded fuel with at least RON 95 (USA = Premium PON91)
Valve timing	4 valves over rocker arm and 1 overhead camshaft, camshaft drive through single chain
Valve diameter Intake	35 mm
Valve diameter Exhaust	30 mm
Valve clearance cold Intake	0.12 mm
Valve clearance cold Exhaust	0.12 mm
Crank shaft bearing	2 cylinder roller bearing
Connecting rod bearing	needle bearing
Top end bearing	bronze bushing
Piston	aluminium alloy forged
Piston rings	1 compression ring, 1 oil scraper ring
Engine lubrication	pressure circulation lubrication with two rotor pumps
Engine oil	full synthetic oil (Motorex Power Synt 4T SAE 10W50)
Quantity of engine oil	1.0 liter
Primary ratio	straight geared spur wheels 29:78 Z
Clutch	mult disc clutch in oil bath
Transmission (claw shifted)	6-speed
Gear ratio	
1st gear	14:33
2nd gear	17:30
3rd gear	19:26
4th gear	23:25
5th gear	24:22
6th gear	27:20
Ignition system	contactless DC - CDI ignition with digital advanced system, Typ KOKUSAN
Generator	12V 150W
Spark plug	NGK DCPR 8 E
Spark plug gap	0.6 mm
Cooling system	liquid cooled, permanent rotation through mechanically driven water pump
Cooling liquid	1.0 liter, 50% antifreeze, 50% distilled water, at least -25° C
Starting equipment	kickstarter/electric starter

BASIC CARBURETOR SETTING			
	FE 450e/6 EU/AUS-UK	FE 450e/6 USA	FS 450e/6 EU
Type of carburetor	Keihin FCR-MX 39	Keihin FCR-MX 39	Keihin FCR-MX 41
Carburetor ID number	3925C	3925C	4125D
Main jet	178	178	182
Jet needle	OBDVT (OBDVR)	OBDVT	OBDVT
Idling jet	38 (40)	38	38
Main air jet	200	200	200
Idle air jet	100	100	100
Needle	2nd from top (6th from top)	2nd from top	2nd from top
Starting jet	85	85	85
Mixture control screw open	1.5 (2)	1.5	1.5
Slide	15	15	15
Restriction	slide stop	—	slide stop
Pump diaphragm stop	858 / 2.15 mm	858 / 2.15 mm	858 / 2.15 mm
Hot start knob	ø 2.5 mm	ø 2.5 mm	ø 2.5 mm

TECHNICAL DATA - ENGINE

ENGINE	FE 550e/6	FE, FS 650e/6	FS 650c/6
Design	Liquid-cooled, 1-cylinder 4-stroke Otto engine with balancer weight		
Displacement	549.8 cc	628.3 cc	
Bore/Stroke	100 / 70 mm	100 / 80 mm	
Ratio	11.8:1	11.8:1	
Carburetor Keihin	FCR-MX 41		
Fuel	unleaded fuel with at least RON 95 (USA = Premium PON 91)		
Valve timing	4 valves controlled over rocker arm and 1 camshaft, camshaft drive with single chain		
Valve diameter Intake	35 mm		
Valve diameter Exhaust	30 mm		
Valve clearance cold Intake	0.12 mm		
Valve clearance cold Exhaust	0.12 mm		
Crank shaft bearing	2 roller bearings		
Connecting rod bearing	needle bearing		
Top end bearing	bronze bush		
Piston	Light alloy – forged		
Piston rings	1 compression ring, 1 oil scraper ring		
Engine lubrication	pressure lubrication with trochoid rotor pump		
Engine oil	fully synthetic engine oil (Motorex Power Synt 4T SAE 10W50)		
Quantity of engine oil	1.0 Liter		
Primary ratio	straight-toothed spur wheels 29:78t		
Clutch	multi-disk clutch in oil bath		
Transmission (claw shifted)	6-speed		
Gear ratio			
1st gear	14:33		
2nd gear	17:30		
3rd gear	19:26		
4th gear	23:25		
5th gear	24:22		
6th gear	27:20		
Ignition system	breakerless transistorized DC-CDI ignition system with digital ignition advance, type KOKUSAN		
Generator	12V 150W		
Spark plug	NGK DCPR 8 E		
Spark plug gap	0.6 mm		
Cooling system	liquid cooled, permanent circulation of cooling liquid through water pump		
Cooling liquid	1.0 liter, mixing ratio 50% antifreeze, 50% distilled water, at least -25° C		
Starting equipment	kickstarter/electric starter		

BASIC CARBURETOR SETTING					
	FE 550e/6 EU/AUS-UK	FE 550e/6 USA	FE, FS 650e/6 EU	FE 650e/6 USA	FS 650c/6 EU
Type of carburetor	Keihin FCR-MX 41	Keihin FCR-MX 41	Keihin FCR-MX 41	Keihin FCR-MX 41	Keihin FCR-MX 41
Carburetor ID number	4125D	4125D	4138E	4138E	4138E
Main jet	182	182	160	160	160
Jet needle	OBDVT (OBDVR)	OBDVT	OBDVT (OBEKR)	OBDVT	OBEKR
Idling jet	38 (40)	38	38 (45)	38	45
Main air jet	200	200	200	200	200
Idle air jet	100	100	100	100	100
Needle position	5th from top	5th from top	2nd from top	2nd from top	4th from top
Starting jet	85	85	85	85	85
Mixture control screw open	1.5	1.5	0.5	0.5	1.5
Slide	15	15	15	15	15
Restriction	slide stop	—	slide stop	—	—
Pump diaphragm stop	858 / 2.15 mm	858 / 2.15 mm	858 / 2.15 mm	858 / 2.15 mm	858 / 2.15 mm
Hot start knob	diameter 2.5 mm	diameter 2.5 mm	diameter 3.8 mm	diameter 3.8 mm	diameter 3.8 mm

TECHNICAL DATA - ENGINE

TIGHTENING TORQUES		
HH collar screws on housing, clutch cover, ignition cover	M6	10 Nm
Oil drain plug	M12x1,5	20 Nm
HH plug oil screen	M20x1,5	15 Nm
AH collar screw on oil filter cover	M5	6 Nm
Plug on pressure relief valve	M12x1,5	20 Nm
HH screws on oil pump cover	M4	Loctite 243 + 5 Nm
HH collar screw on cylinder head top section	M6	10 Nm
AH screws on valve cover	M5	6 Nm
HH collar screws on water pump cover	M6	10 Nm
HH screws on cylinder head	M10	50 Nm
HH screw on cylinder head	M6	10 Nm
AH screws on camshaft gear	M8	Loctite 243 + 28 Nm
HH nut on automatic decompression stop	M5	Loctite 270 + 8 Nm
AH screws on rocker arm shaft silencer cap	M5	Loctite 243 + 6 Nm
Counternut on valve adjusting screw	M6x0,75	11 Nm
HH nut on primary pinion	M16x1	Loctite 2701 + 110 Nm
HH nut on idler shaft gear	M16x1	Loctite 2701 + 110 Nm
HH nut on clutch drive	M18x1,5	Loctite 243 + 120 Nm
HH collar screws on clutch springs	M6	Loctite 243 + 8 Nm
AH screw shift on shift roller lock	M6	Loctite 243 + 10 Nm
HH collar screw on locking lever	M6	Loctite 243 + 10 Nm
HH collar screw on shift roller bearing	M6	Loctite 243 + 10 Nm
HH collar screws on chain tensioner	M6	10 Nm
HH screw chain tensioning rail	M5	Loctite 243 + 6 Nm
HH screw on chain guide rail	M6	Loctite 243 + 6 Nm
HH collar screws on stator FE/FS models	M6	Loctite 243 + 10 Nm
HH collar screws on pulse generator	M5	Loctite 243 + 6 Nm
HH collar nut on rotor	M12x1	60 Nm
HH screw on kickstarter	M6	Loctite 243 + 25 Nm
Phillips screws on kickstarter release plate	M5	Loctite 243 + 6 Nm
HH collar screw on shift lever	M6	10 Nm
Spark plug	M12x1,25	20 Nm
Plug on engine blocking bore	M8	20 Nm
Diaphragm valve	M4	Loctite 243 + 1,5 Nm

TECHNICAL DATA - CHASSIS

CHASSIS	FE 450, 550, 650e/6	FS 450, 650e/6	FS 650c/6
Frame	tubular chrome-molybdenum-steel frame, powder-coated		
Fork	WP Up Side Down 4860 MXMA + PA		
Spring travel, front/rear	295/320 mm	275/288 mm	
Rear suspension	WP Progressive Damping System shock absorber, aluminum rear swinging fork		
Front brake	Ø 260 mm brake disk, floating brake caliper	Ø 310 mm radial brake caliper	
Brake disk front	minimum thickness 2.5 mm	minimum thickness 4.5 mm	
Rear brake	Disk brake, perforated Ø 220 mm brake disk, floating brake caliper		
Brake disk rear	minimum thickness 3.5 mm	minimum thickness 4.5 mm	
Front tire	90/90 - 21"	120/70 - 17"	12/60 - 17"
Air pressure, off road	1.0 bar	-	-
Air pressure, on road/alone	1.5 bar	1.5 bar	1.5 bar
Rear tire	140/80 - 18"	150/60 - 17"	16/63 - 17"
Air pressure, off road	1.0 bar	-	-
Air pressure, on road/alone	2.0 bar	2.0 bar	2.0 bar
Fuel tank capacity	FE: 9 liters / 7.5 liters (EU)		FS: 7.5 liters
Gear ratio - rear wheel	16:40 (14:48, 15:48, 15:45)	16:38 (15:40)	16:38 (15:40)
Chain	5/8x1/4"		
Available rear sprockets	38t, 40t, 42t, 45t, 48t, 49t, 50t, 51t, 52t		
Lighting	Headlight Parking light Brake light Turn signal	HS1 12V 35/35W 12V 5W (socket W2, 1x9,5d) 12V 21/5W (socket BaY15d) 12V 10W (socket Ba15s)	
Battery	maintenance-free battery 12V 7Ah		
Steering head angle	63°	63.5°	
Wheel base	1490 ± 10 mm	1481 ± 10 mm	
Seat height, unloaded	930 mm	870 mm	
Ground clearance, unloaded	380 mm	320 mm	

ENGLISH

STANDARD ADJUSTMENT - FORK

	FE 450, 550, 650e/6 WP 4860 MXMA + PA 14.45.7D.02	FS 450e/6, 650e/6, 650c/6 WP 4860 MXMA + PA 14.45.7D.03
Compression adjuster	19	20
Rebound adjuster	20	15
Spring	4.4 N/mm	4.6 N/mm
Spring preload	2 turns	5 turns
Airchamber lenght	105 mm	100 mm
Fork oil	4860 0401 Motorex	4860 0401 Motorex

STANDARD ADJUSTMENT - SHOCK ABSORBER

	FE 450, 550, 650e/6 WP 5018 PDS DCC 12.45.7D.02	FS 450e/6, 650e/6, 650c/6 WP 5018 PDS DCC 12.45.7D.03
Compression adjuster	18 LS (low speed) 2 HS (high speed)	12 LS (low speed) 2 HS (high speed)
Rebound adjuster	20	10
Spring	84/250	88/250
Spring preload	5 mm	11 mm

TECHNICAL DATA - CHASSIS

TIGHTENING TORQUES - CHASSIS		
Collar screw, front wheel spindle	M24x1,5	40 Nm
Brake caliper, front FE	M8	Loctite 243 + 25 Nm
Brake caliper, front FS	M10	40 Nm
Collar screw brake pads front - FS models only	M6	10 Nm
Brake discs	M6	14 Nm
Clamping screws, upper fork bridge FS + FE	M8	17 Nm
Clamping screws, lower fork bridge FS + FE	M8	12 Nm
Clamping nut fork bridge	M22x1	20 Nm
Clamping screws, fork stubs	M8	15 Nm
Collar nut, rear wheel spindle	M20x1,5	80 Nm
Hexagon nut, swing arm bolt	M16x1,5	100 Nm
Hexagon collar screw, handlebar clamp	M8	20 Nm
Allan head screw, handlebar support	M10	Loctite 243 + 40 Nm
Shock absorber, top	M12	Loctite 243 + 70 Nm
Shock absorber, bottom	M10	40 Nm
Sprocket screws	M8	35 Nm
Ball joint for push rod	M6	Loctite 243 + 10 Nm
Engine mounting bolt	M8	25 Nm
Side stand	M8	20 Nm
Rim lock	M8	10 Nm
Screw adjusting ring spring preload shock abs	M6	8 Nm
Spoke nipple	M4.5 / M5	4.5 - 6 Nm
Other screws on chassis	M6	10 Nm
	M8	25 Nm
	M10	45 Nm
Other collar nuts on chassis	M6	15 Nm
	M8	30 Nm
	M10	50 Nm

HEAD WORD INDEX

	Page		Page
Activating and deactivating display modes	10	Dismounting and mounting the rear wheel	42
Adjusting the mixture control screw	51	Draining the float chamber of the carburetor	52
Adjusting the throttle cables	49	Driving instructions	20
Basic information on carburetor wear	51	Electronic speedometer	8
Basic suspension setup for the weight of the driver	29	Emergency OFF switch (Australia)	8
Battery	45	Engine oil	53
Bleeding of the hydraulic clutch	50	Engine-Number	5
Bleeding the cooling system	48	Filler cap	14
Braking	22	Flasher switch	7
Breather plug front fork	28	Foot brake pedal	15
Carburetor – Adjust idling	51	Fuel	23
Chain maintenance	35	Fuel Taps	14
Chain wear	35	Fuse	46
Changing the basic position of the foot brake pedal	39	General information about Husaberg disc brakes	36
Changing the basic position the hand brake lever (FE)	37	Hand brake lever	6
Changing the basic position the hand brake lever (FS)	37	Hand decompression lever	6
Changing the engine oil	53	Headlamp switch (USA)	7
Changing the fork offset (caster)	31	Hot start device	14
Changing the oil filter	54	How to change the handlebar position	33
Changing the original position of the clutch lever	50	Indicator lamps	7
Changing the spring preload on the telescopic fork	16	Instructions for initial operation	19
Changing the spring preloading of the shock absorber	33	Kickstarter	15
Charging the battery	45	Kilometers or miles	13
Chassis number	5	Maintenance work on chassis and engine	28
Check chain tension	34	Oil circuit	52
Check the following before each start	20	Operation instruments	6
Check the rear brake fluid level	39	Periodic maintenance schedule	24
Check/set distance of the magnetic sensor	44	Plug in stand	16
Checking and adjusting the steering head bearing	27	Rebound damping of fork	16
Checking spoke tension	43	Rebound damping of shock absorber	18
Checking the adjustment of the hand decompression release cable	49	Refilling the front brake fluid reservoir	37
Checking the basic setup of the telescopic fork	30	Refilling the rear brake fluid reservoir	39
Checking the brake fluid level - front brake	37	Replacing fork springs	30
Checking the coolant level	47	Replacing headlight lamp/parking light lamp	46
Checking the engine oil level	53	Replacing the front brake pads (FE)	38
Checking the float level (float height)	52	Replacing the front brake pads (FS)	38
Checking the front brake pads	38	Replacing the glassfiber yarn packing of the silencer	48
Checking the oil level of the hydraulic clutch	50	Replacing the rear brake pads	40
Checking the rear brake pads	40	Running in the Husaberg models	19
Checking the shock absorber and spring	29	Serial number locations	5
Checking the shock absorption rubbers in the rear hub	43	Setting the clock	13
Choke	14	Shift lever	15
Cleaning the air filter	49	Shifting/Riding	22
Cleaning the dust sleeves of the telescopic fork	28	Short circuit button	6
Cleaning the oil screen	53	Side stand	15
Cleaning the spark arrester	48	Starter button	8
Cleaning, Conservation, Storage	57	Starting off	22
Clutch lever	6	Starting when the engine is cold	21
Combination switch	7	Starting when the engine is warm	21
Compression damping of fork	16	Steering lock	18
Cooling system	47	Stopping and parking	23
Correct chain tension	34	Technical data - chassis	61
Damping action during compression of shock absorber	17	Technical data - engine	59
Determining the riding sag of the shock absorber	29	Tips and warnings for starting the motorcycle	19
Determining the static sag of the shock absorber	29	Tires, air pressure	44
Dismounting and mounting the front wheel	41	Troubleshooting	55
		What to do when the engine is "flooded"	21
		Wiring diagram	appendix

SCHALTPLAN / WIRING DIAGRAM

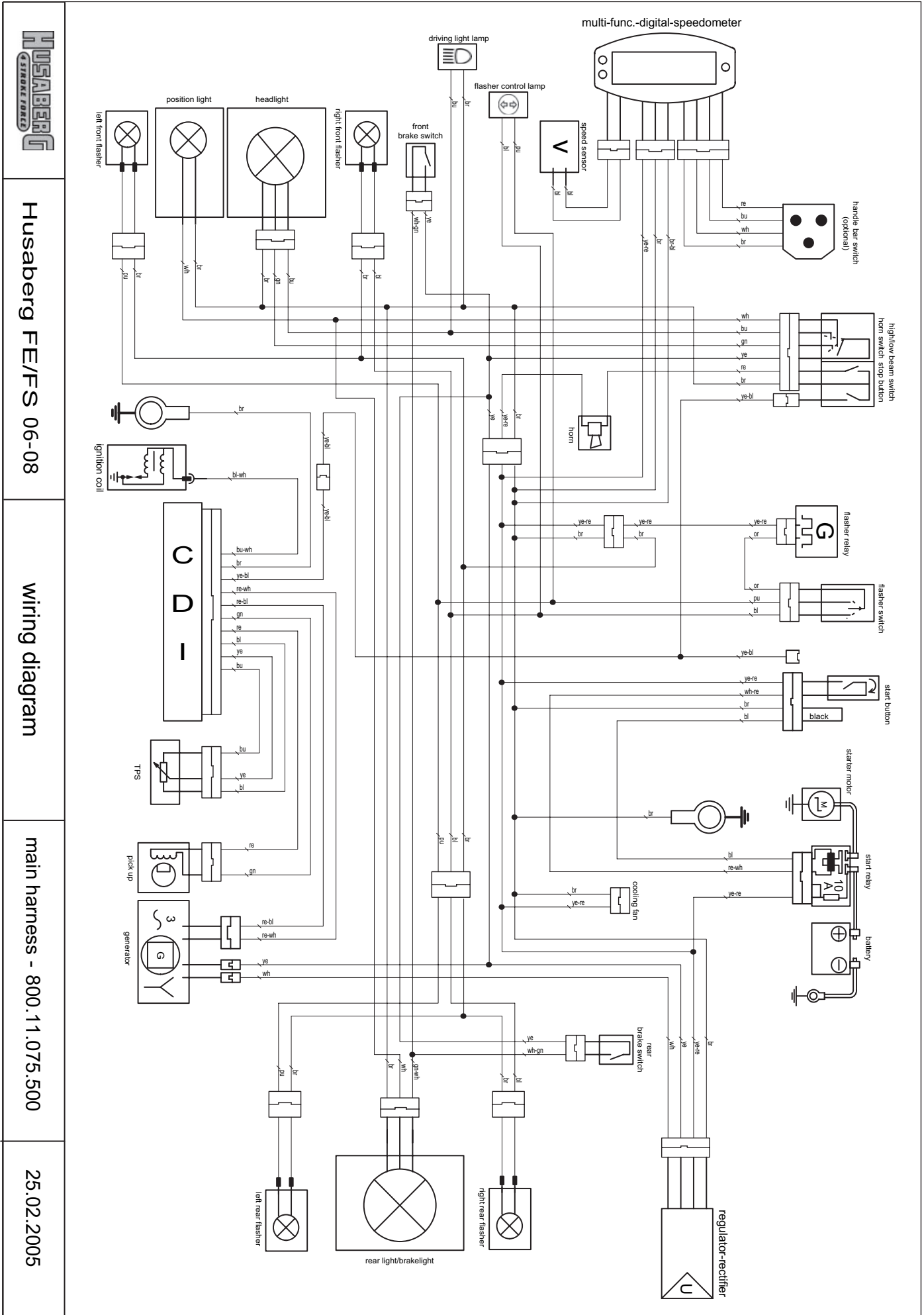





SCHALTPLAN / WIRING DIAGRAM

horn switch

cable color	re	br
HORN 	●	●
OFF		



light switch
high/low beam switch

cable color	bu	ye	gn	wh
LIGHT OFF				
P.LIGHT 		●	●	●
LO 		●	●	
HI 	●	●		
P.LIGHT 		●	●	

brake switch

cable harness	gn-wh	ye
cable switch	bl	bl
pushed	●	●
unpushed		

flasher switch

cable harness	or	pu	bl
TURN L 	●	●	
TURN R 	●	●	●
OFF			

start switch

cable switch	re-wh	ye-re
START 	●	●
unpushed		

kill switch

cable color	ye-bl	br
pushed	●	●
unpushed		

SCHALTPLAN / WIRING DIAGRAM

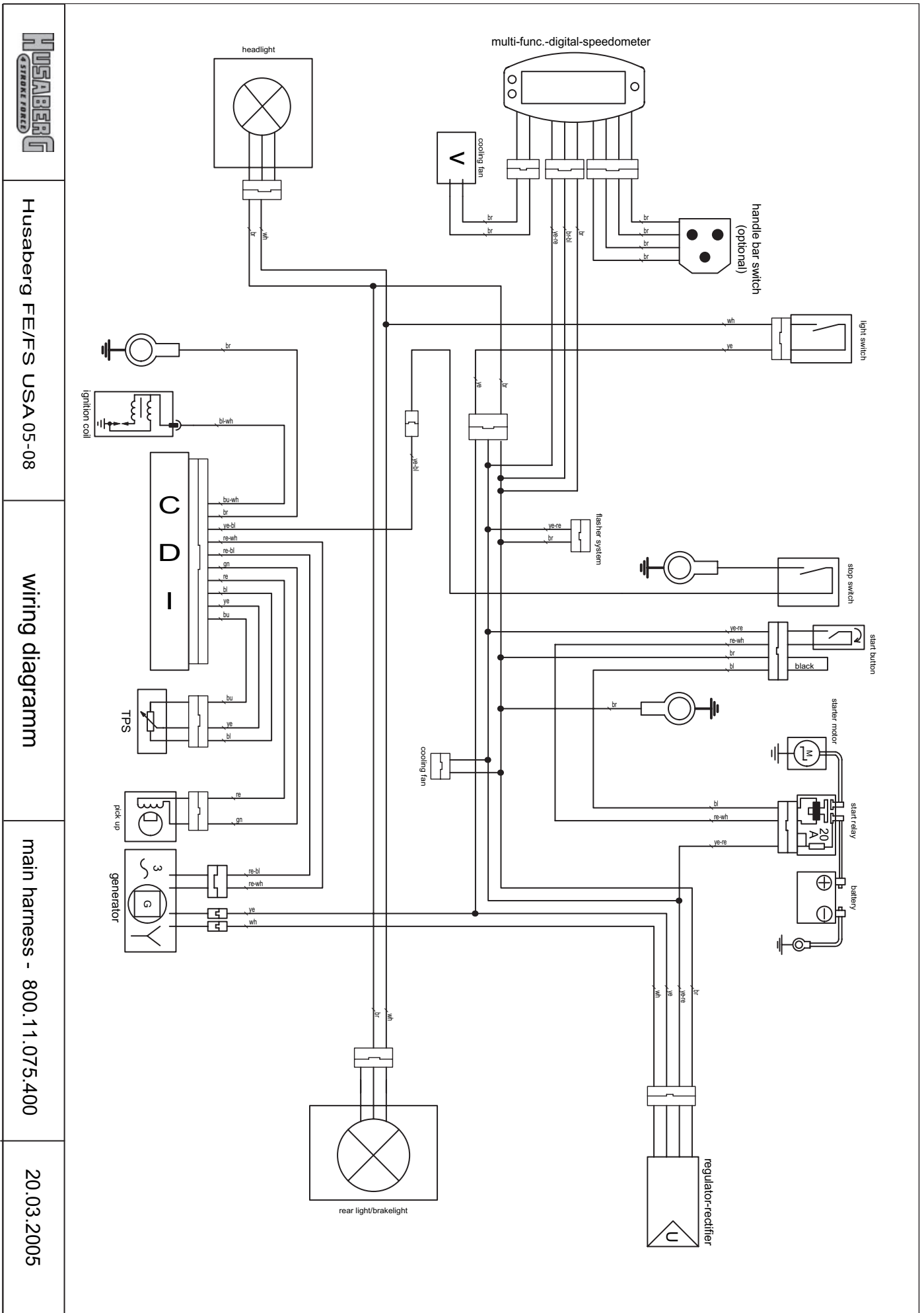

Husaberg FE/FS USA 05-08

wiring diagramm

main harness - 800.11.075.400

20.03.2005

ANHANG-APPENDIX
APPENDICE

SCHALTPLAN / WIRING DIAGRAM

ENGLISH	DEUTSCH	FRANCAIS
Battery Cooling fan Driving light lamp Flasher control lamp Flasher relay	Batterie Lüftermotor Fernlichtkontrolllampe Blinkerkontrollampe Blinkerrelais	Batterie Ventilateur temoin feu route temoin de clignoteur Relais de clignotants
Flasher switch Flasher system Front brake switch Generator Handle bar switch for multi-func.-digital-speedometer	Blinkerschalter Blinksystem vorderer Bremslichtschalter Generator Lenkerschalter für Multifunkt.Digitaltacho	Bouton de clignotants Systeme de clignotants Contacteur de frein avant Alternateur Contacteur au guidon pour ordinateur de bord
Headlight High / low beam switch Horn Horn switch Ignition coil	Scheinwerfer Auf-Abblendschalter Hupe Hornscharter Zündspule	Phare Contacteur code/phare Avertisseur sonore Bouton d'avertisseur sonore Bobine d'allumage
Ignition switch Left front flasher Left rear flasher Light switch Multi-func.-digital-speedometer	Zündschloss linker vorderer Blinker linker hinterer Blinker Lichtschalter Multifunktionsdigitaltacho	Contacteur d'allumage Clignotant avant gauche Clignotant arrière gauche Contacteur d'éclairage Ordinateur de bord
Pick up Position light Rear brake switch Rear light / brakelight Regulator-rectifier	Impulsgeber Begrenzungslicht hinterer Bremslichtschalter hinteres Begrenzungslicht / Bremslicht Regelgleichrichter	Capteur d'allumage feu de position Contacteur de frein arrière Feu rouge/stop Régulateur/redresseur
Right front flasher Right rear flasher Speed sensor Start relay Start/stop button	rechter vorderer Blinker Rechter hinterer Blinker Geschwindigkeitssensor Startrelais Start / Stop schalter	Clignotant avant droit Clignotant arrière droit Capteur de vitesse Relais de démarreur Contacteur start/stop
Starter motor Temperature switch Throttle position sensor (TPS)	Startermotor Temperaturschalter Vergaserpotentiometer	Démarreur Contacteur de température Capteur d'ouverture de carburateur

CABLE COLOURS	KABELFARBEN	COULEUR DE CABLE
bl: black ye: yellow bu: blue gn: green re: red wh: white br: brown or: orange pi: pink gr: grey pu: purple	bl: schwarz ye: gelb bu: blau gn: grün re: rot wh: weiß br: braun or: orange pi: rosa gr: grau pu: violett	bl: noir ye: jaune bu: bleu gn: vert re: rouge wh: blanc br: brun or: orange pi: rose gr: gris pu: violet



HUSABERG - a part of the KTM Group
Stallhofner Straße 3, A-5230 Mattighofena
E-mail: info@husaberg.cc, Internet: www.husaberg.cc